



ALBUM
rysunków do kursu
FUNDAMENTOWANIA
według wykładów
prof. J. FEDOROWICZA

Nakładem Koła Inżynierji Lądowej
Studentów Politechniki Warszawskiej
Warszawa rok 1932

1.2.18130

B.3466

I. zasady ogólne

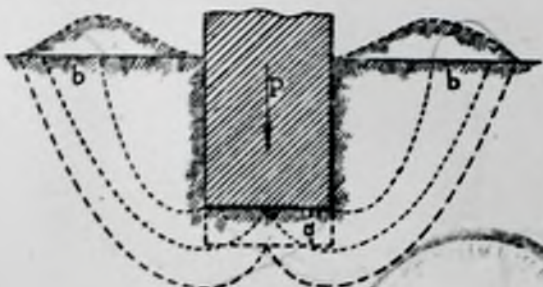

RYS.1

a - osiadanie gruntu
b - usuwanie się gruntu

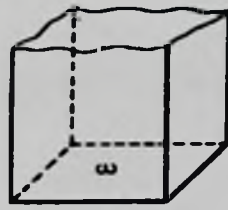

RYS.2

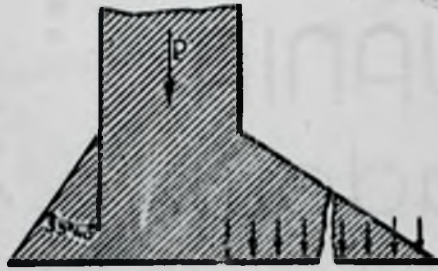
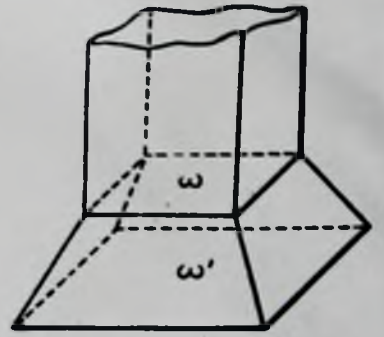

RYS.3

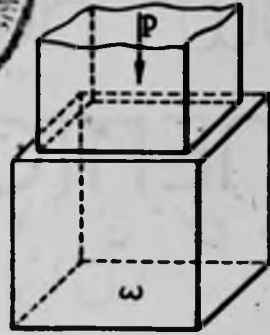

RYS.4

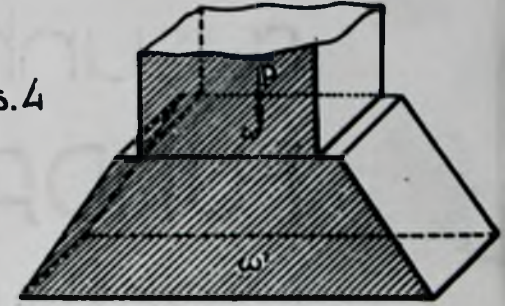

$$\frac{P}{\omega} - p < q \quad \frac{P}{\omega'} - p' - q$$

$$\frac{P}{\omega} - p = q$$

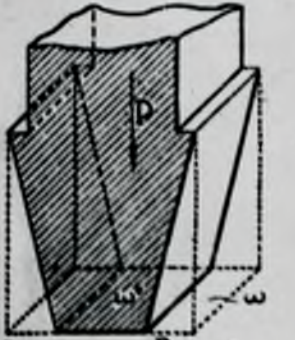

$$\frac{P}{\omega} - p > q \quad \frac{P}{\omega'} - p' - q$$

RYS.5a

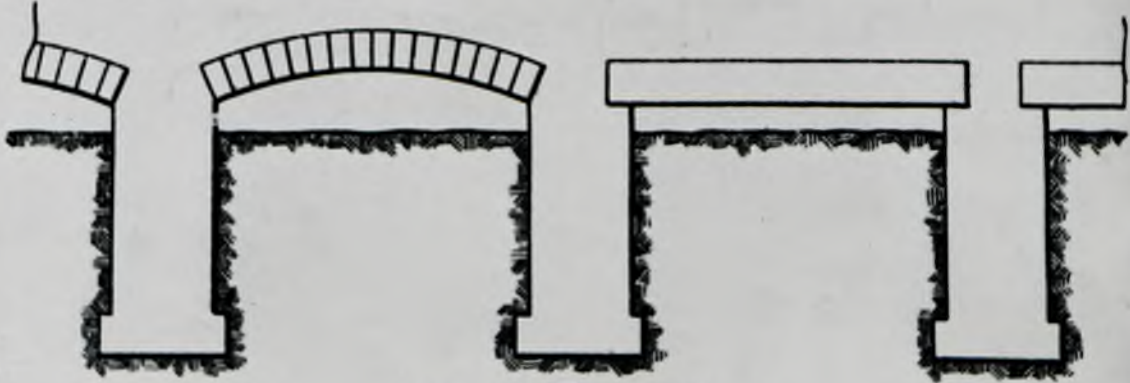

RYS.5b $\frac{P}{\omega'} - p' = q$

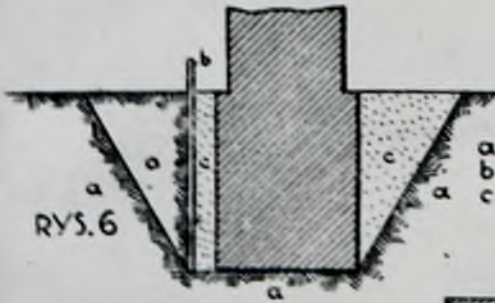

RYS.6

a - elina
b - deski
c - piasek żużel lub żyz

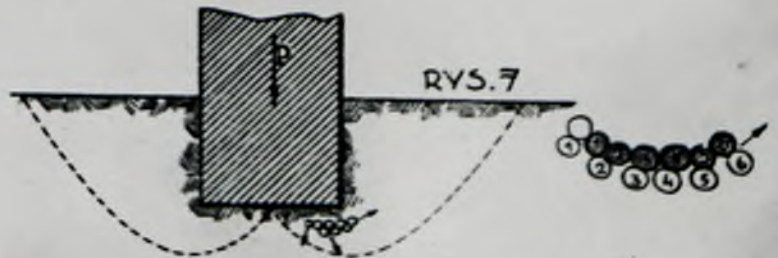

RYS.7

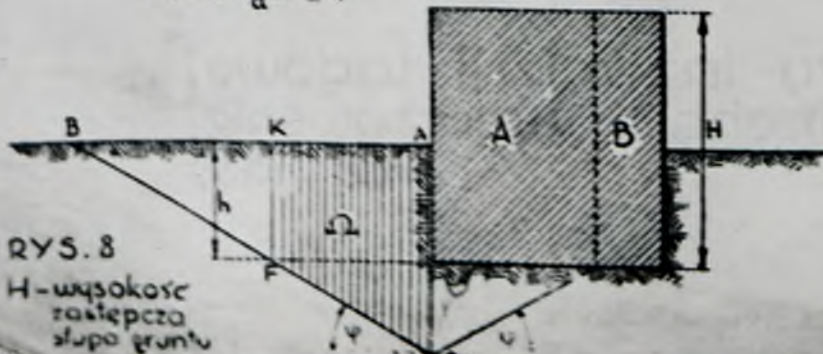

RYS.8

H - wysokość wystająca słupa gruntu



RYS.9

A - budowa
B - skafa
C - warstwa wodonośna/piasek, żwirak, glina z piaskiem

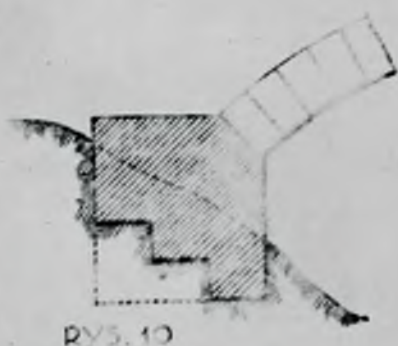

RYS. 10

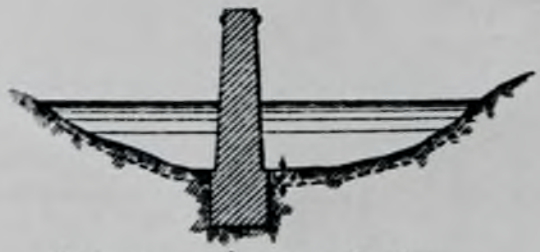

RYS. 11a h-wymycie dna

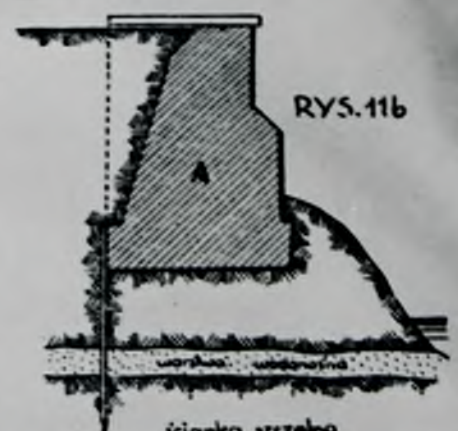

RYS. 11b



RYS. 12



RYS. 13

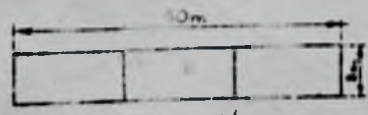
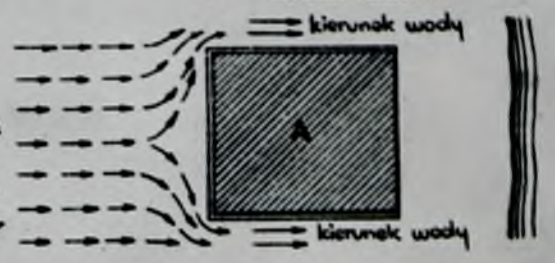

RYS. 14

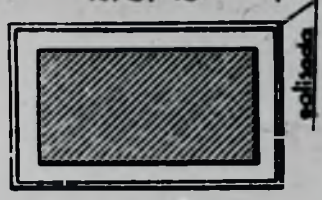

RYS. 16

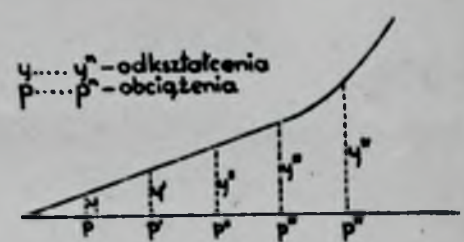

RYS. 15

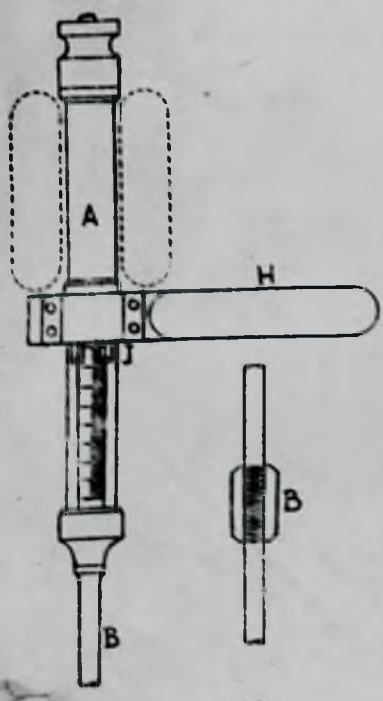

RYS. 17



RYS. 18 wykres odkształceń otrzymany na mocy badań gruntu

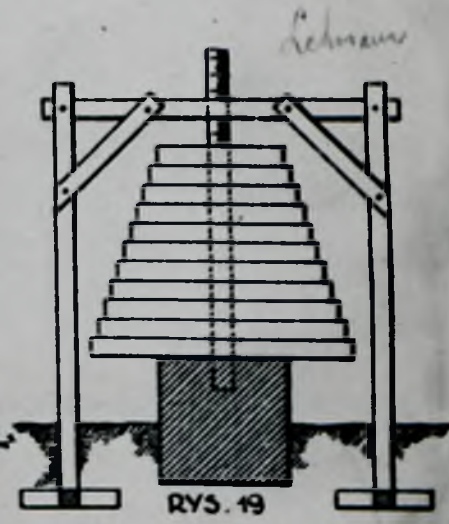
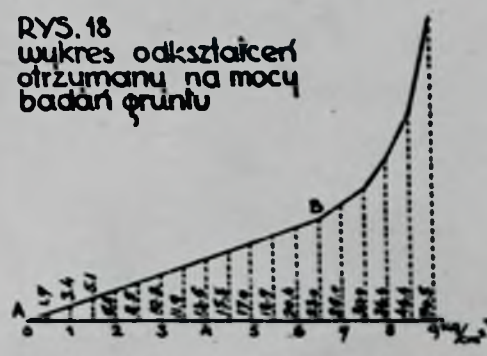

RYS. 19



RYS. 20

II. fundamenty budynków

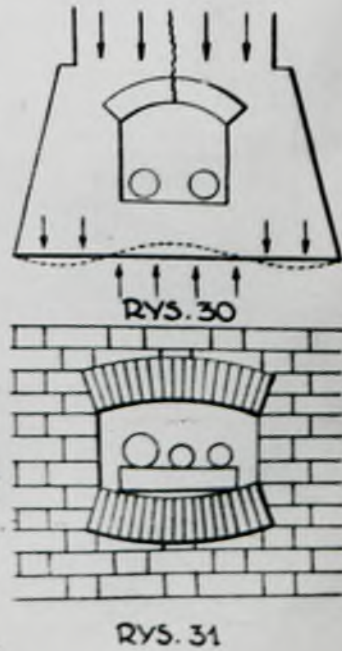
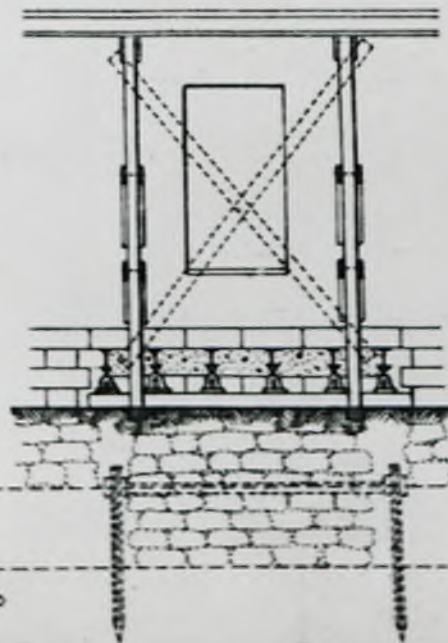
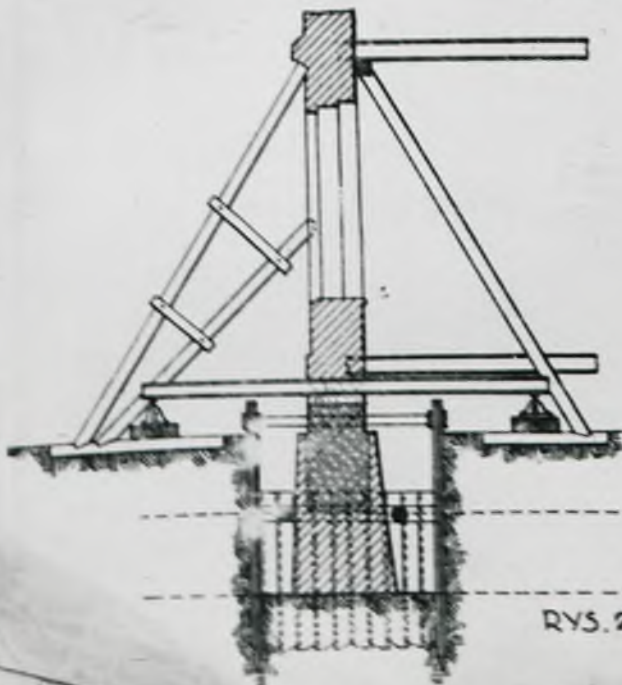
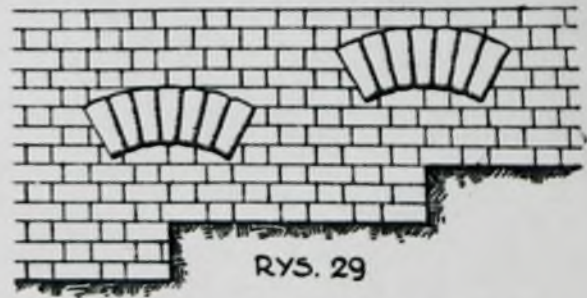
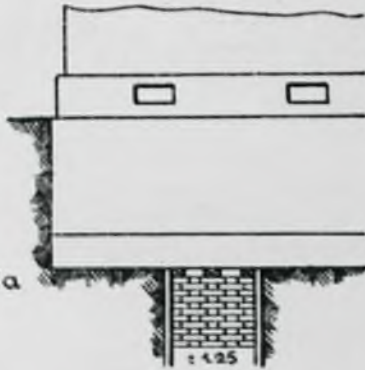
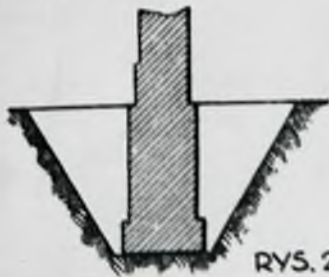
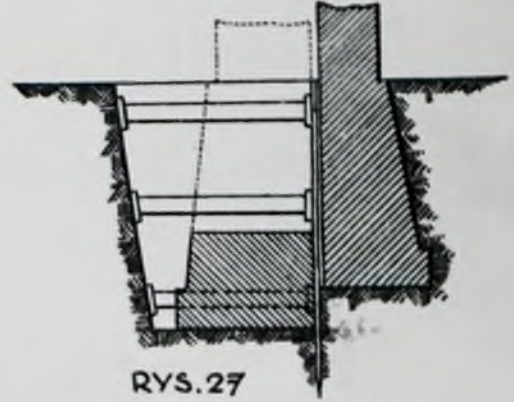
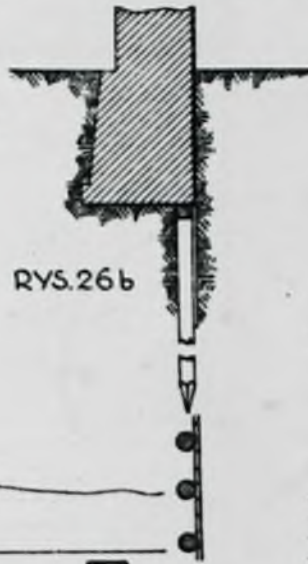
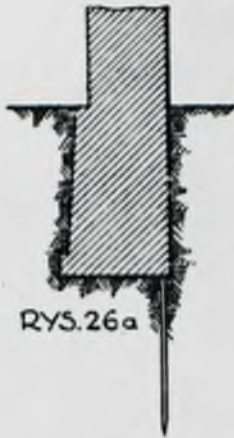
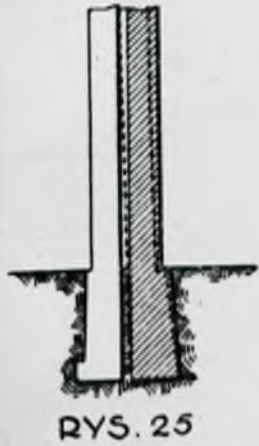
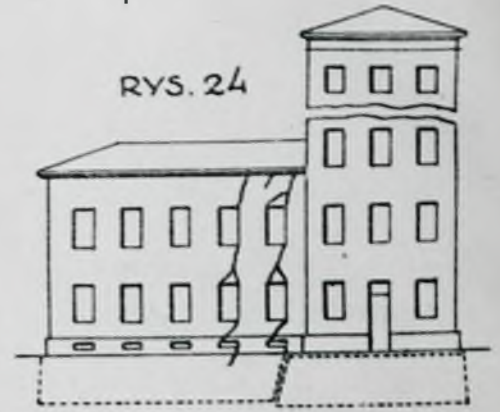
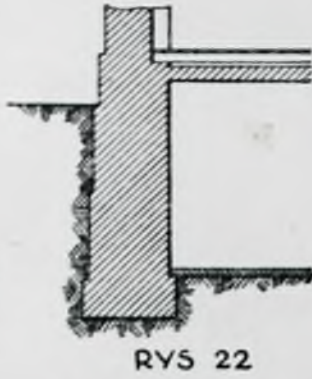
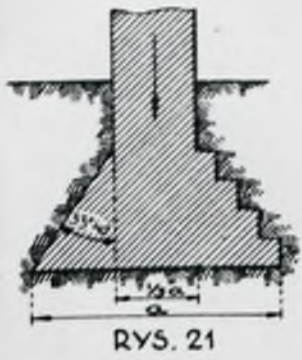

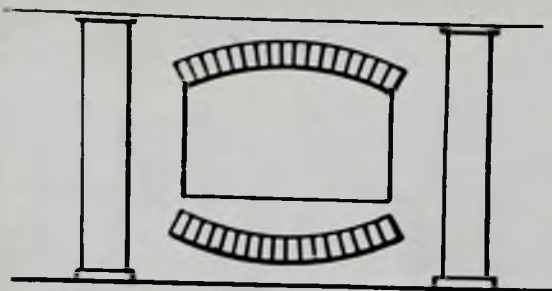

RYS. 32

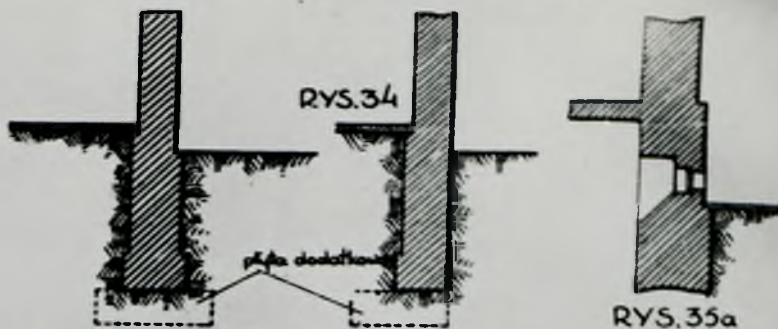

RYS. 34

RYS. 35a

RYS. 33

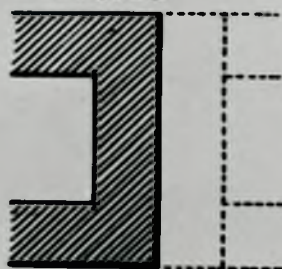

RYS. 35b

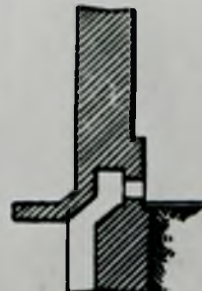

RYS. 35c

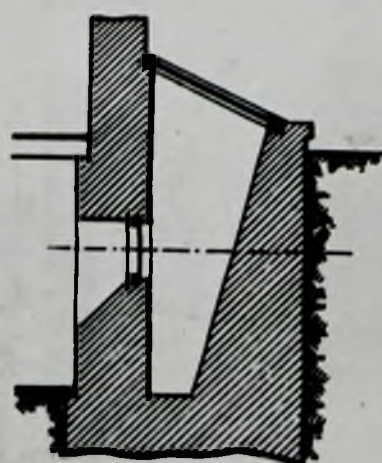

RYS. 36



RYS. 37

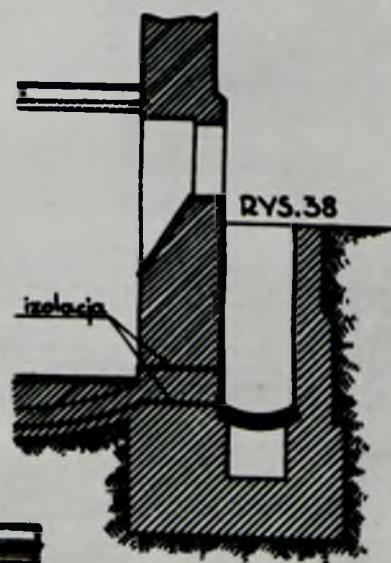

RYS. 38

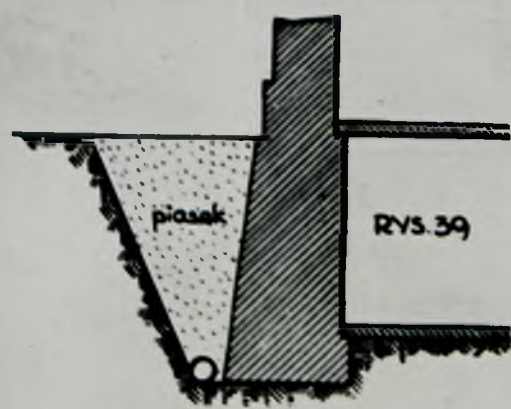
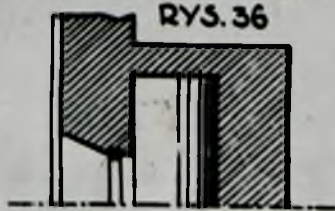

RYS. 39



RYS. 41a

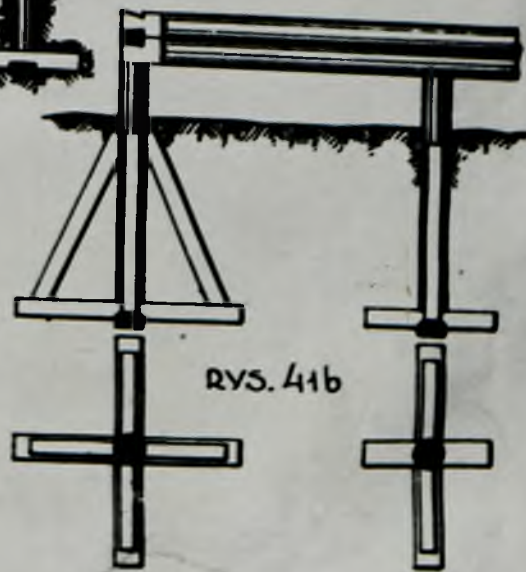

RYS. 41b

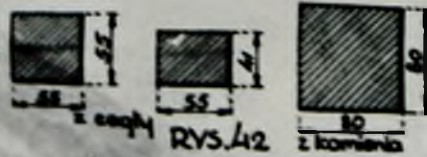

RYS. 42

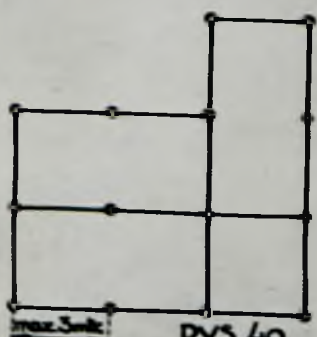

RYS. 40



RYS. 43

RYS. 44

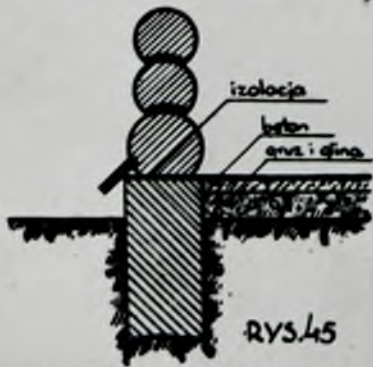

RYS. 45

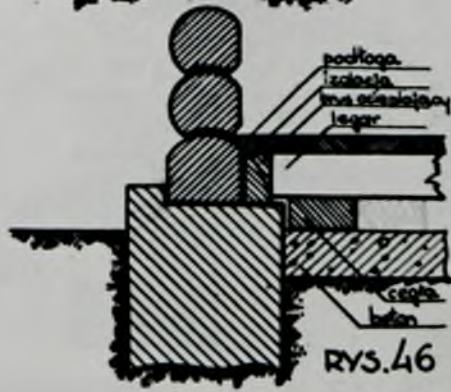

RYS. 46

III. wyznaczanie robot.

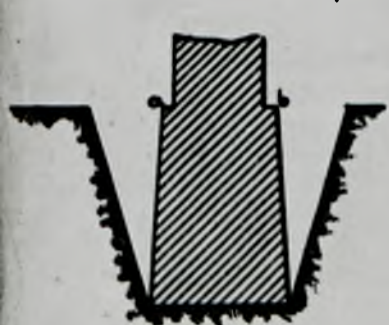

RYS. 47a

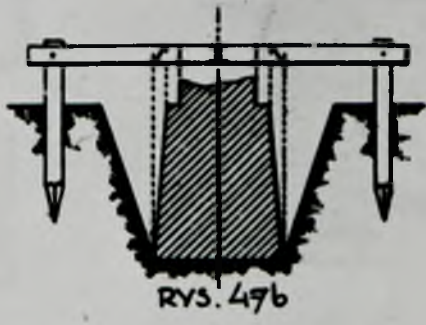

RYS. 47b

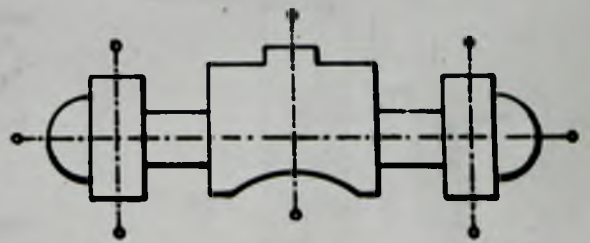

RYS. 48

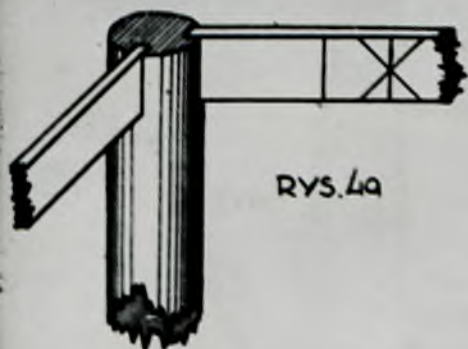

RYS. 49a

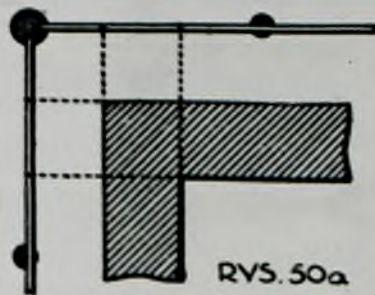

RYS. 50a



RYS. 50b

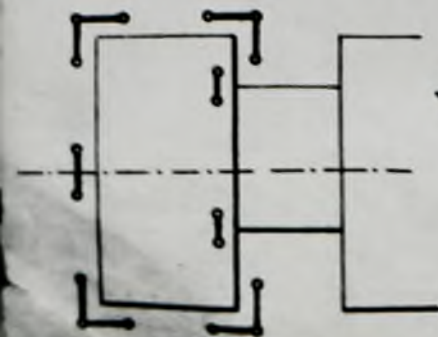

RYS. 51



RYS. 52a



RYS. 52b

RYS. 53

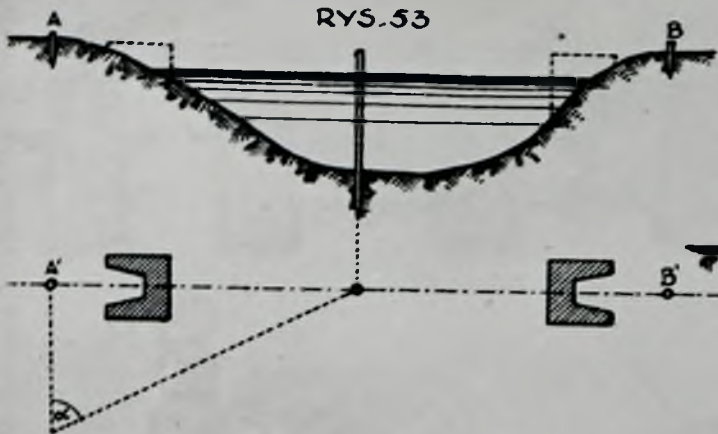

RYS. 54a

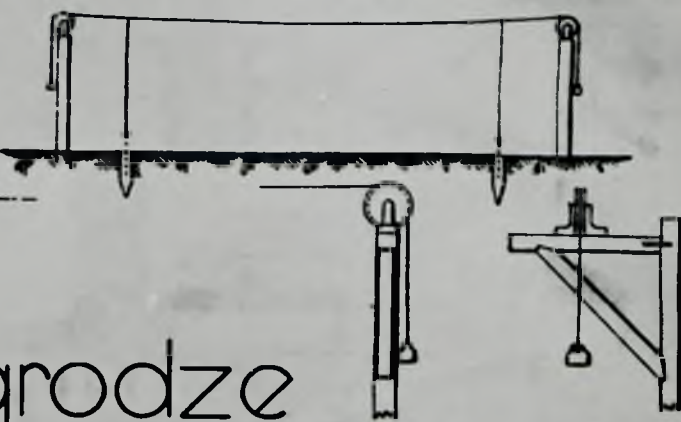

IV. grodze



RYS. 55

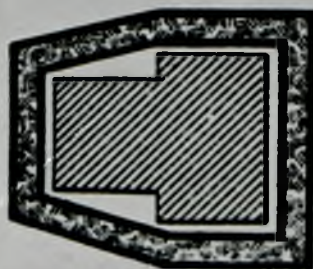

RYS. 56

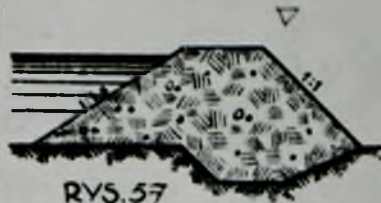

RYS. 57



RYS. 58



RYS. 59

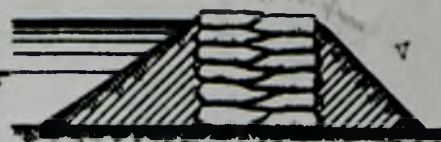

RYS. 60

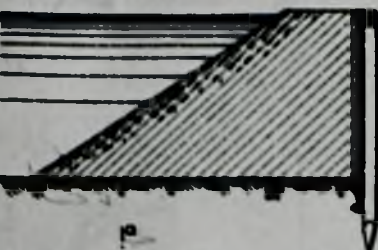

RYS. 61

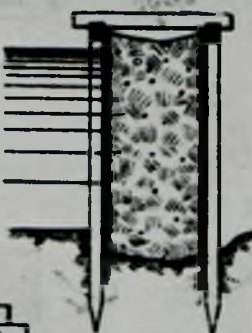
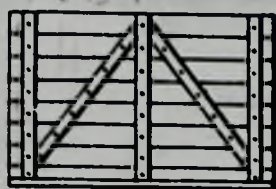

RYS. 62

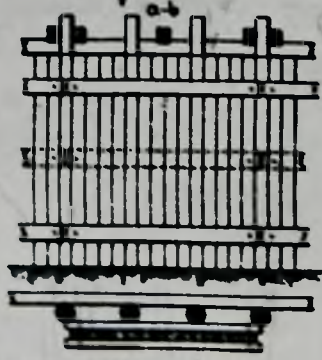
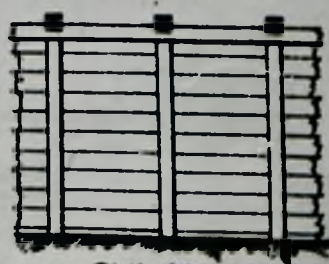

RYS. 64

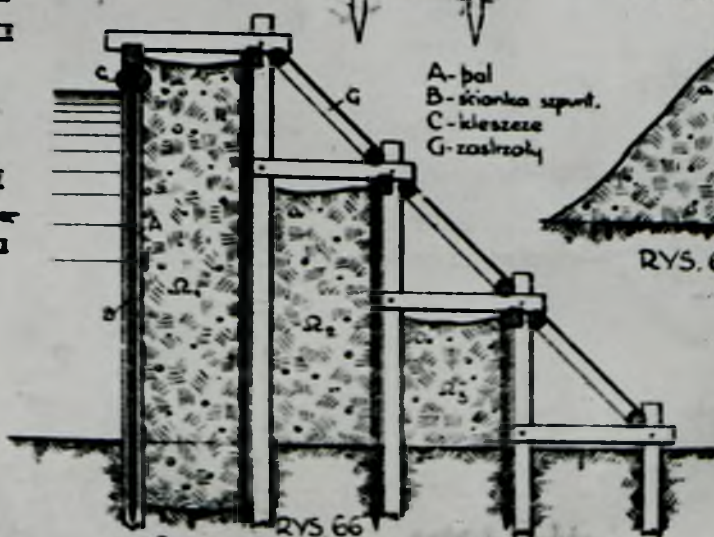

A - bal
 B - ścianka szpurt.
 C - kieszenie
 G - żaluzja

RYS. 66

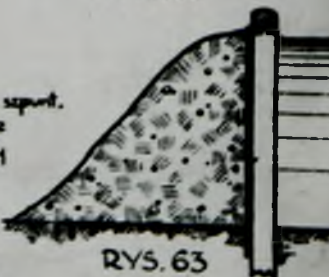

RYS. 63

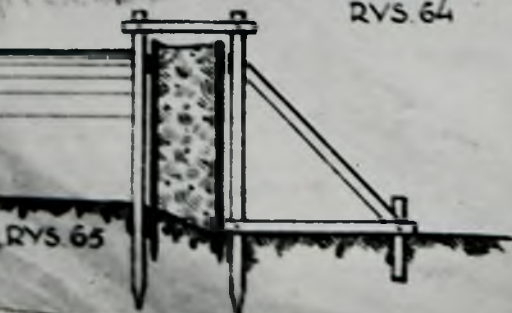

RYS. 65

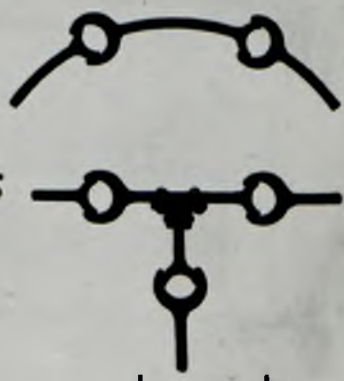
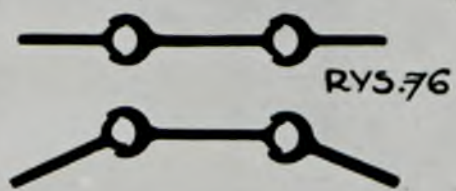
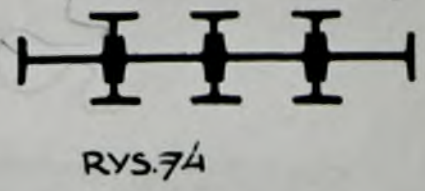
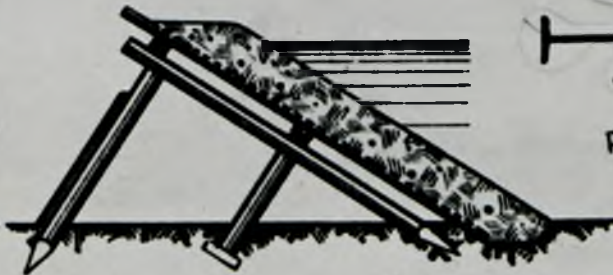
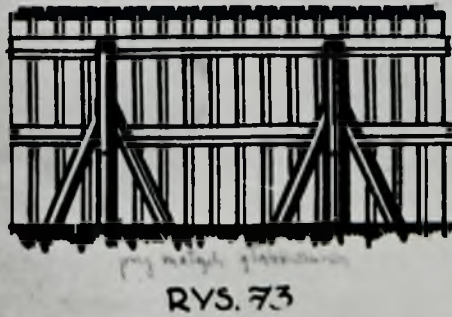
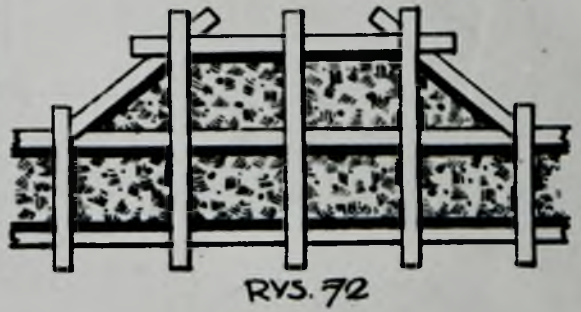
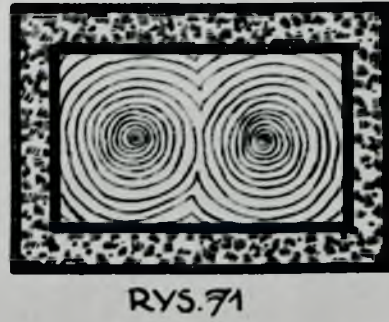
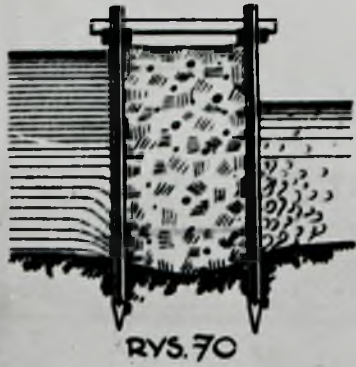
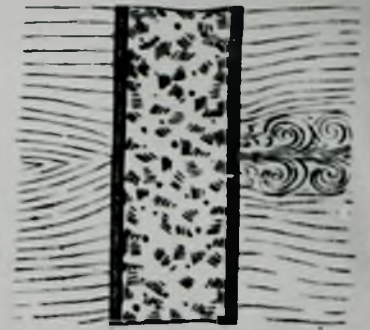
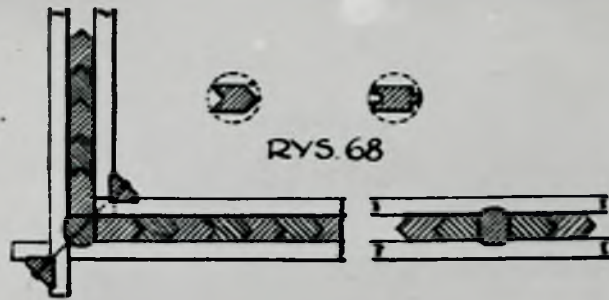
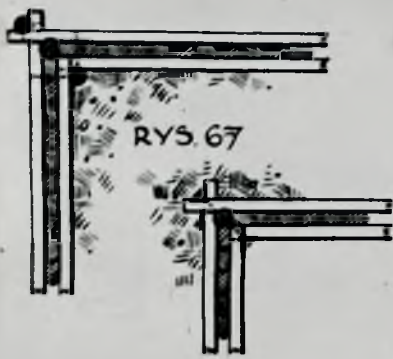

v.rusztę na palach

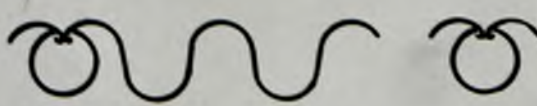

RYS. 77

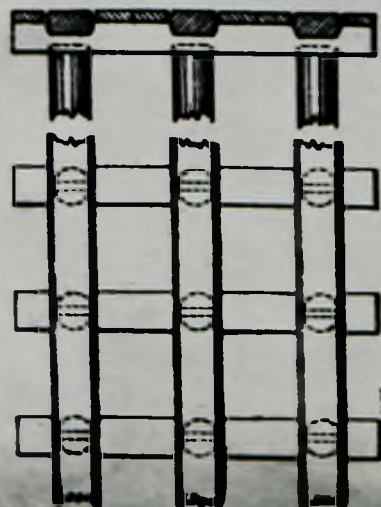

RYS. 78

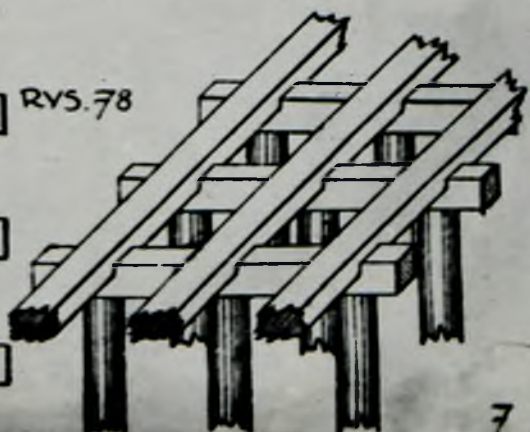

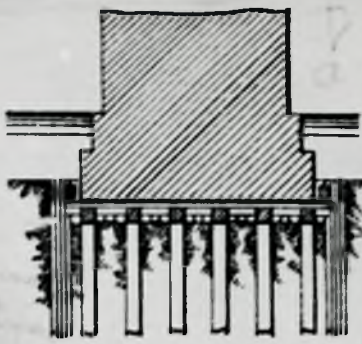

RYS. 79

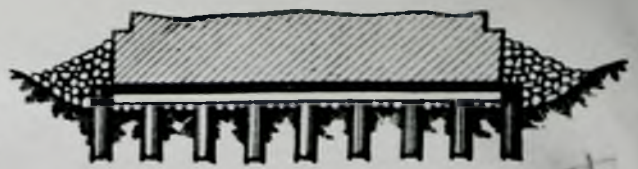
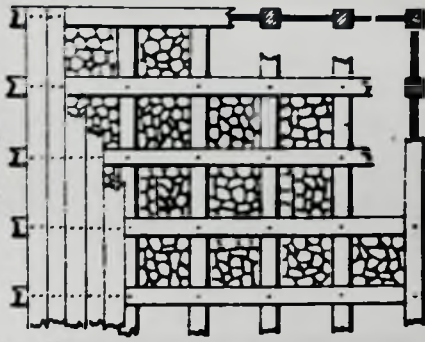

RYS. 80

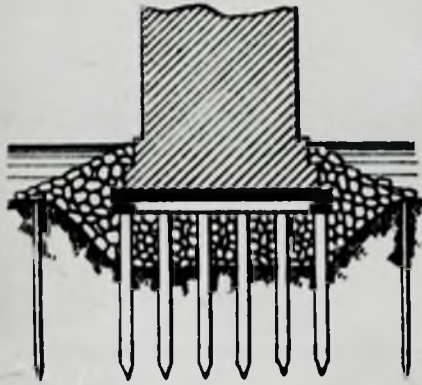
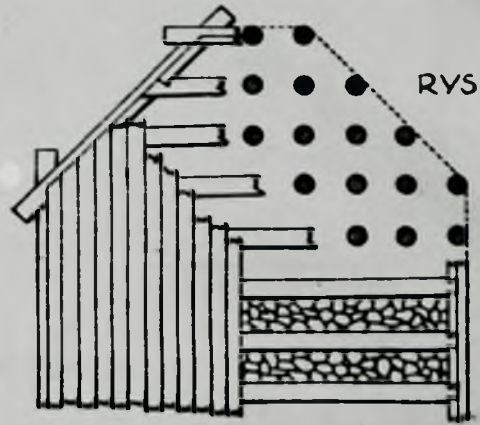

RYS. 81

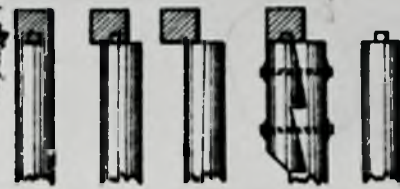

RYS. 82



RYS. 83

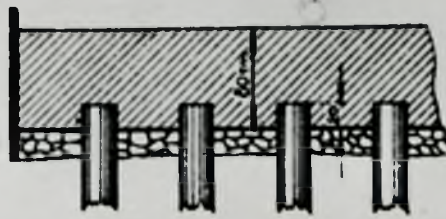

RYS. 85

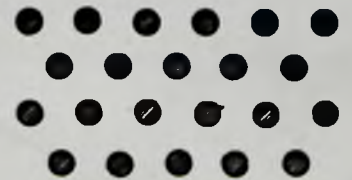

RYS. 86

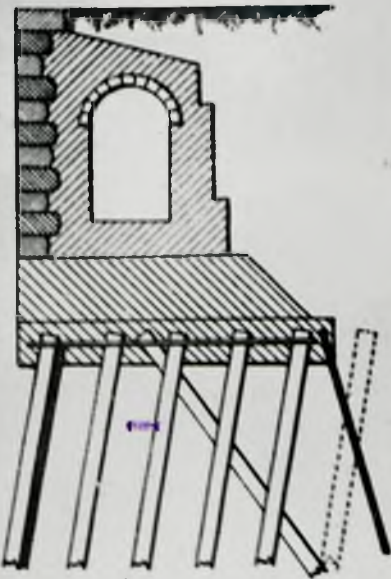

RYS. 84

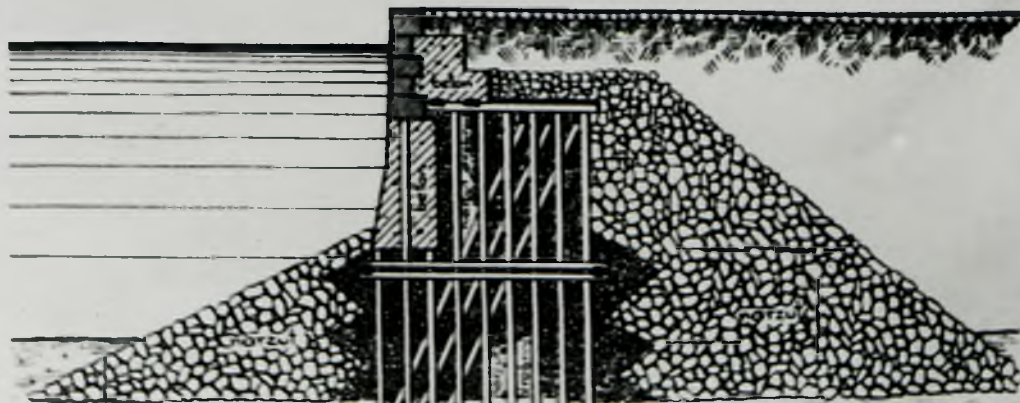

RYS. 89

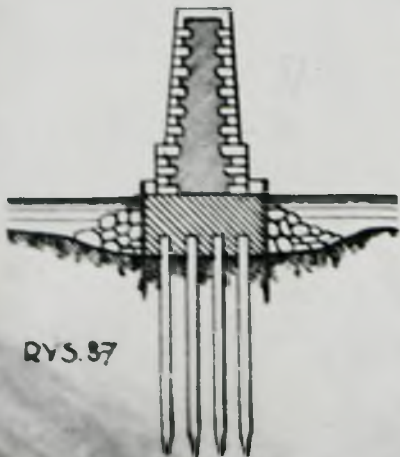

RYS. 87

VI. szczytnie bez dna

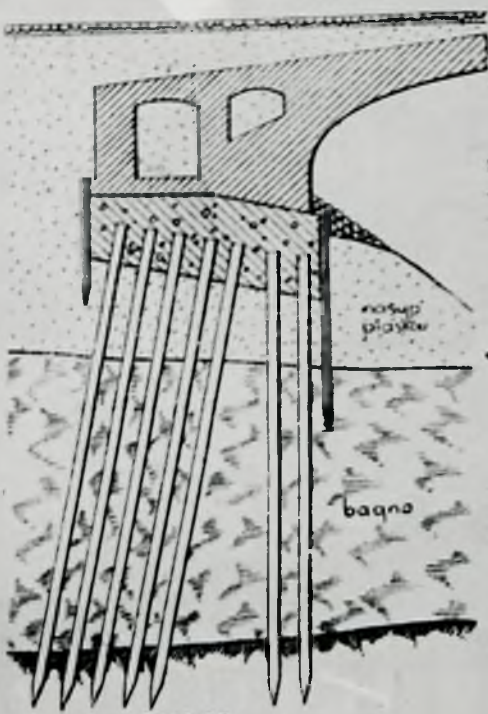

RYS. 89

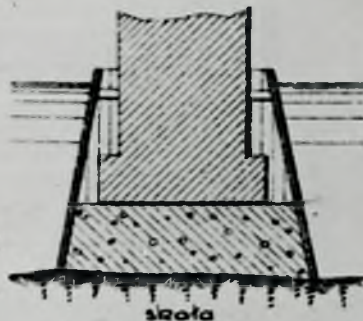

RYS. 90a

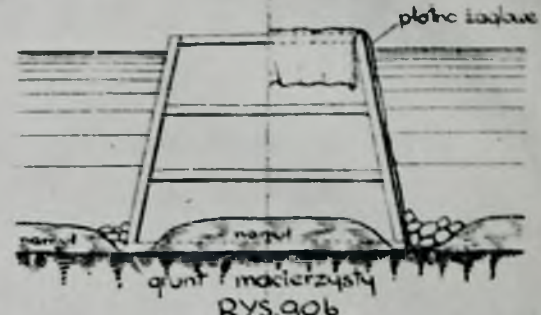

RYS. 90b



RYS. 92a



RYS. 92b

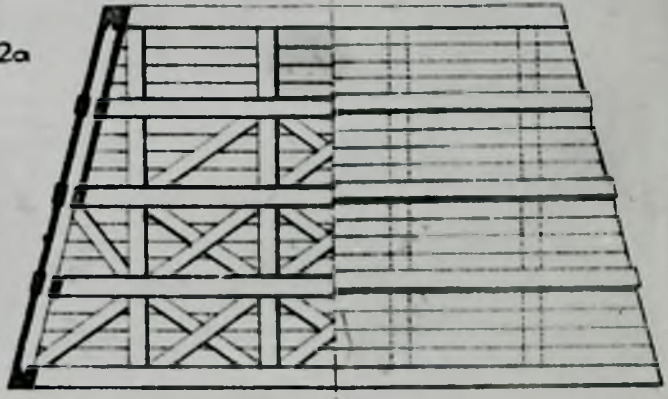

RYS. 91



RYS. 93a

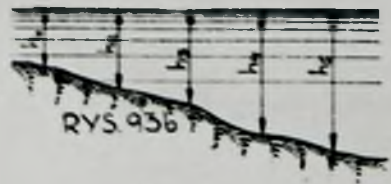

RYS. 93b

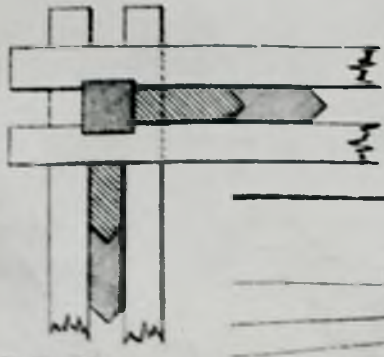

RYS. 94

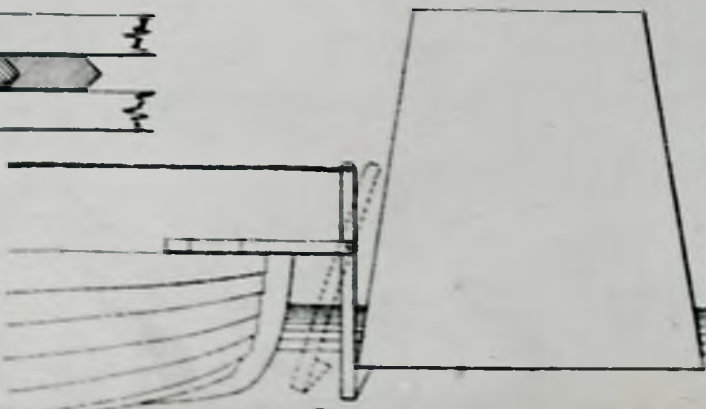

RYS. 95



RYS. 96

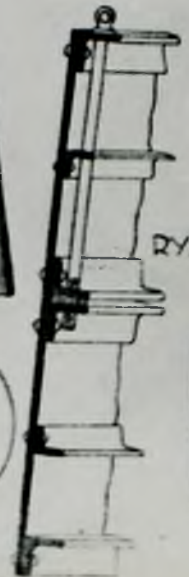

RYS. 97



VII. skrzynie pływające

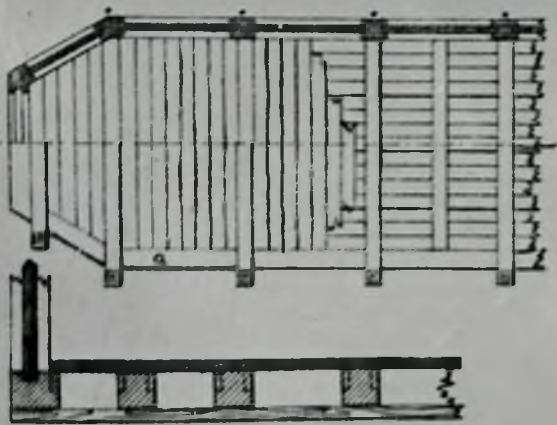

RYS.98

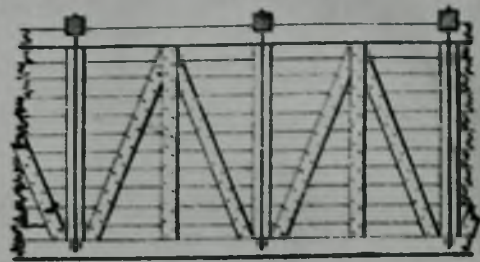
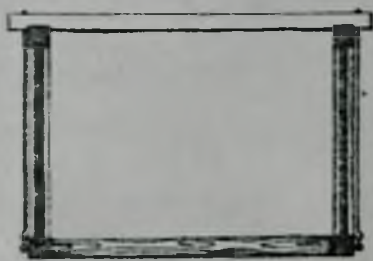

RYS.99

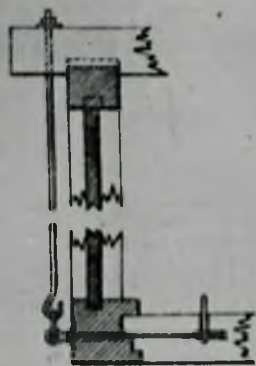

RYS.100

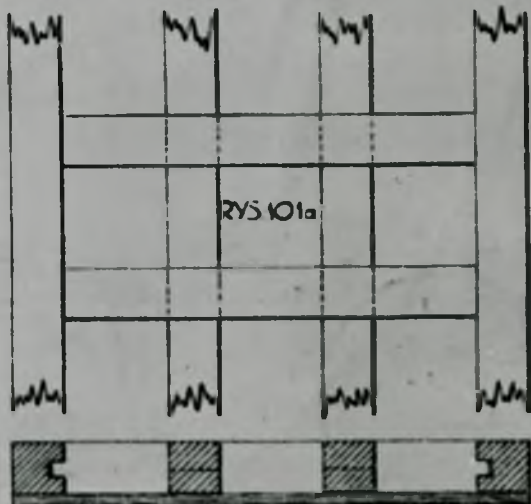

RYS.101a



RYS.101b



RYS.101c



RYS.101d

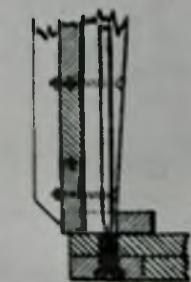
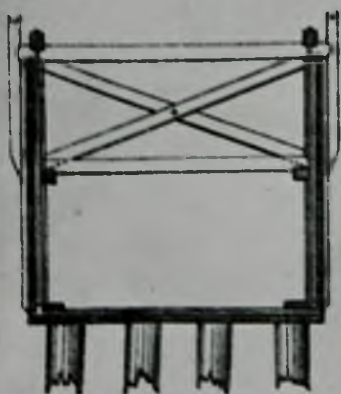

RYS.102

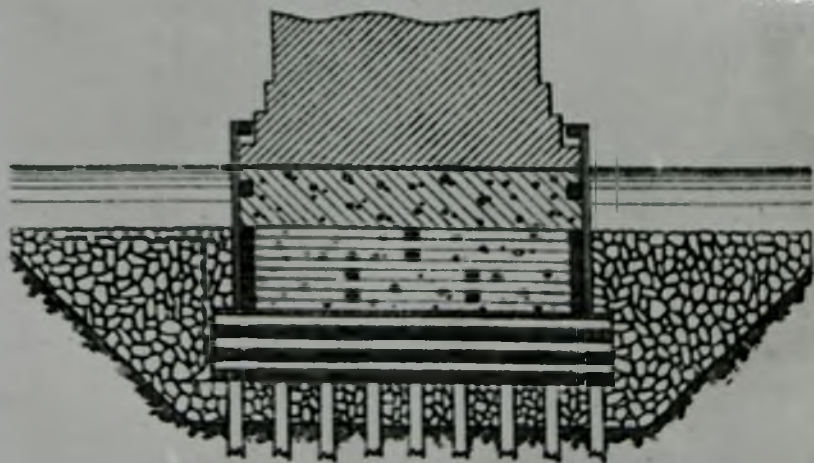

RYS.103

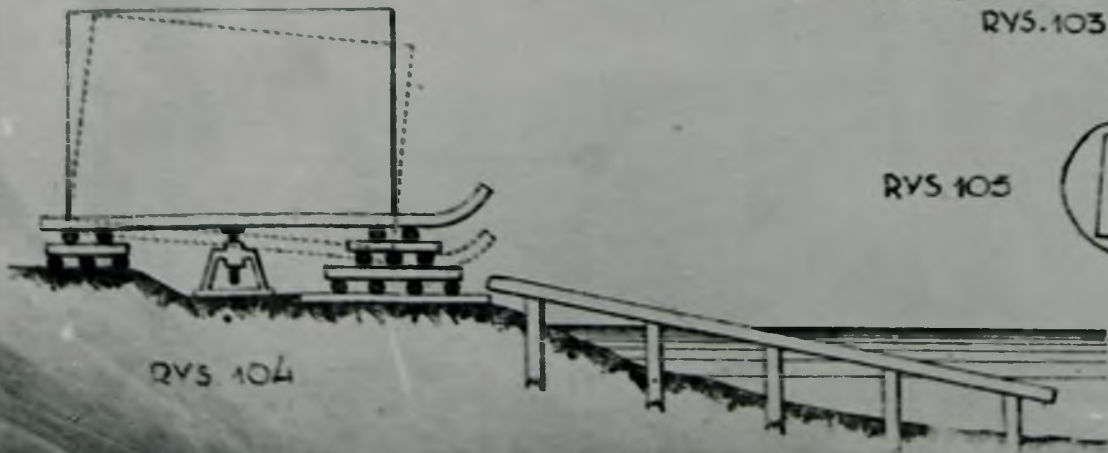

RYS.104

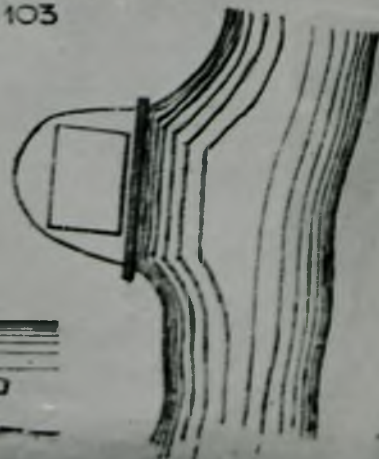

RYS.105



A': A'' - statki
B - skrzynia
RYS. 106

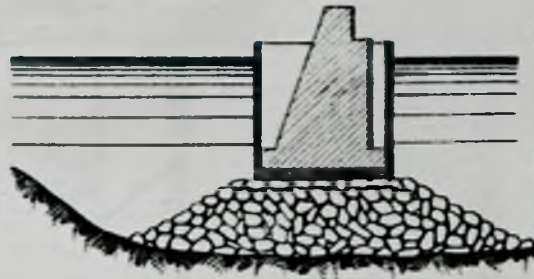

RYS. 107

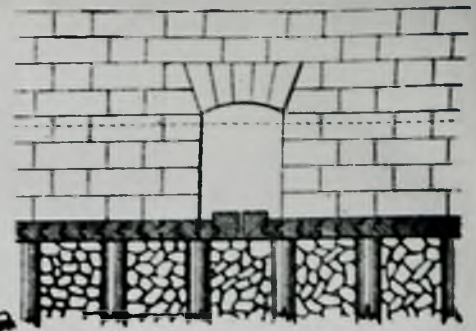

RYS. 108

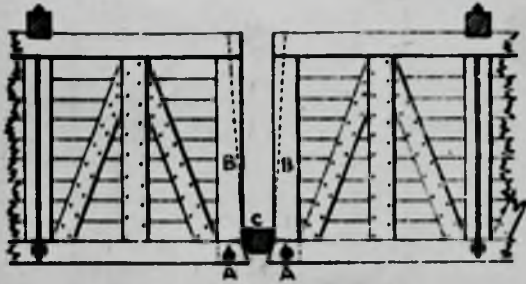

RYS. 109a

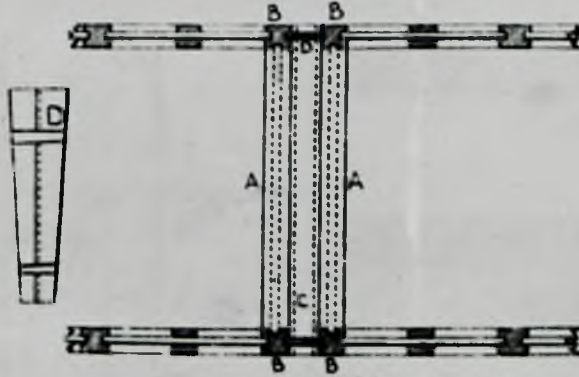

RYS 109b



RYS. 110

RYS. 111

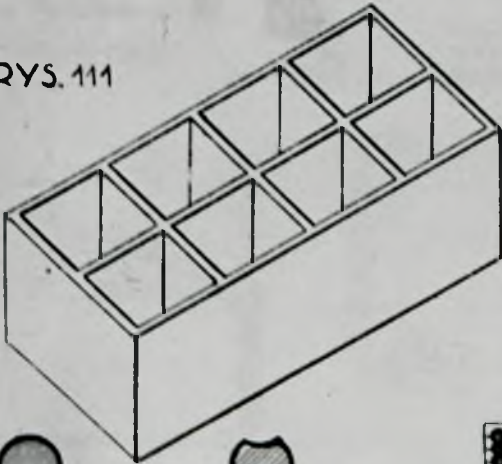

RYS. 114

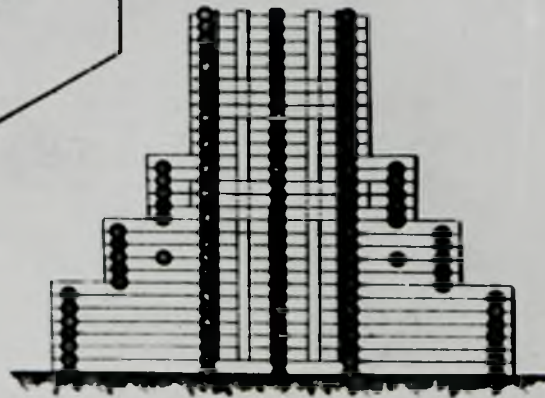

RYS. 112

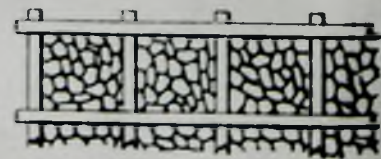
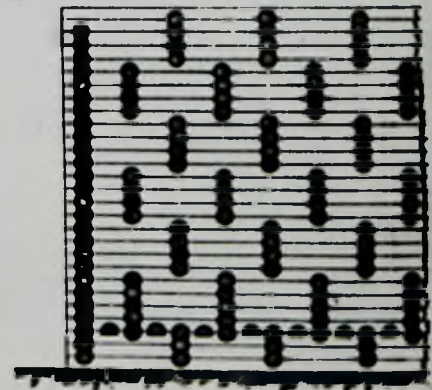

RYS. 113

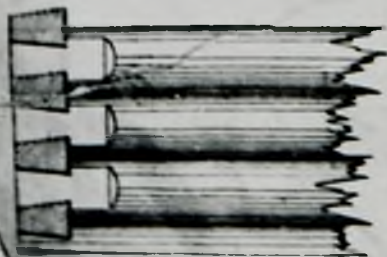

RYS. 115



RYS. 116



RYS. 117

VIII. kaszycy

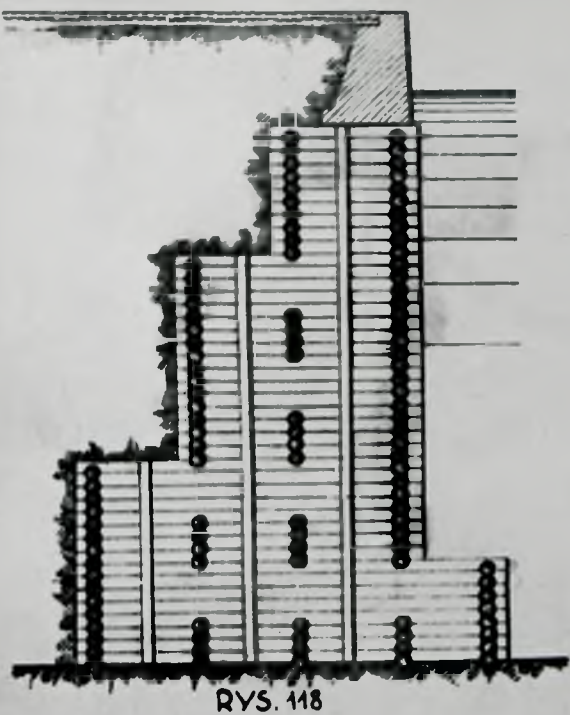

RYS. 118

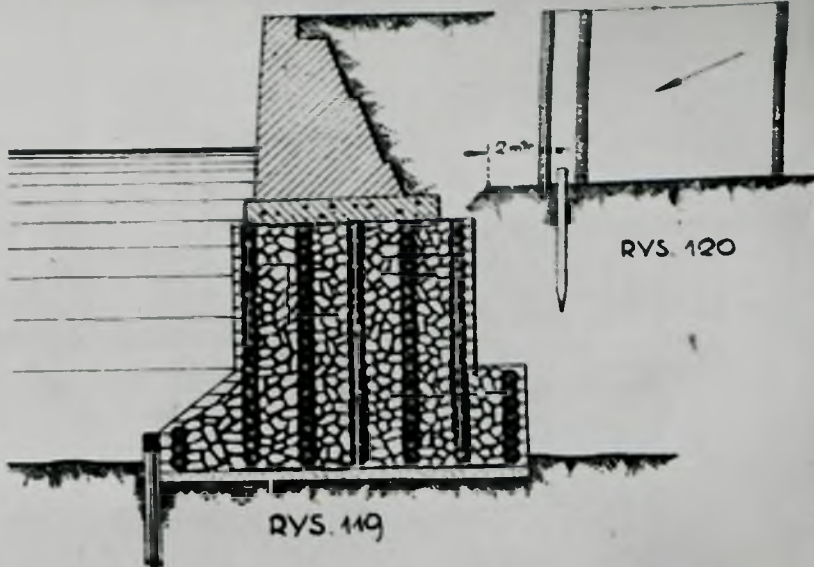

RYS. 119

RYS. 120

Σ fundowanie pod sprężonem powietrzem

α/ wskazówki ogólne

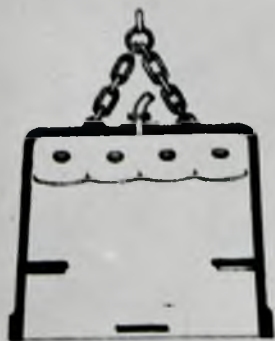

RYS. 121

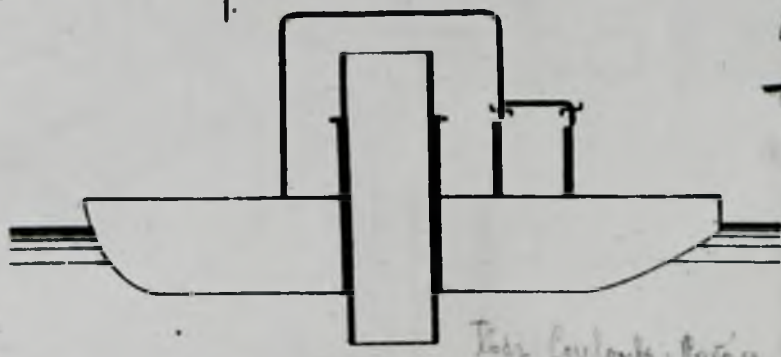

RYS. 122

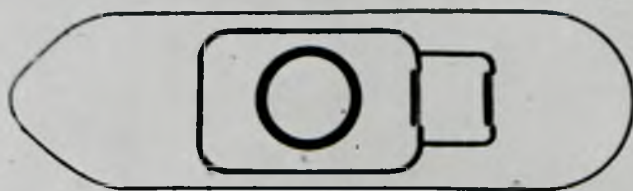

RYS. 124

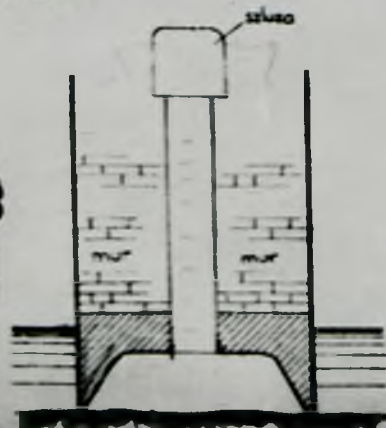

RYS. 126

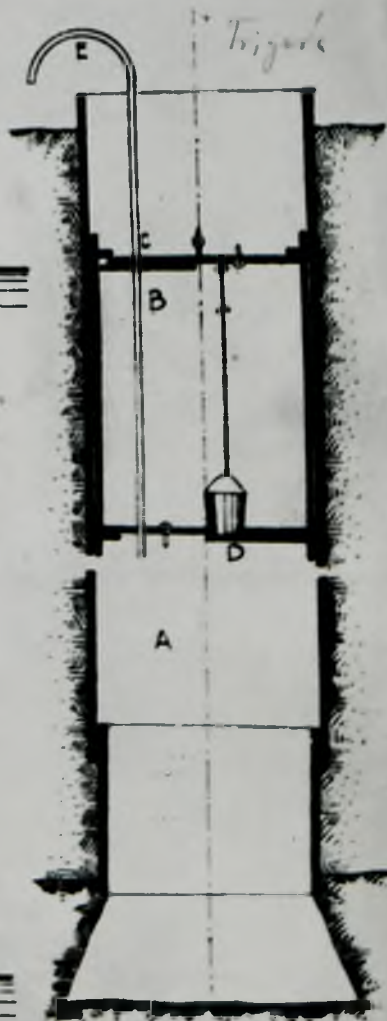

RYS. 125

Grund

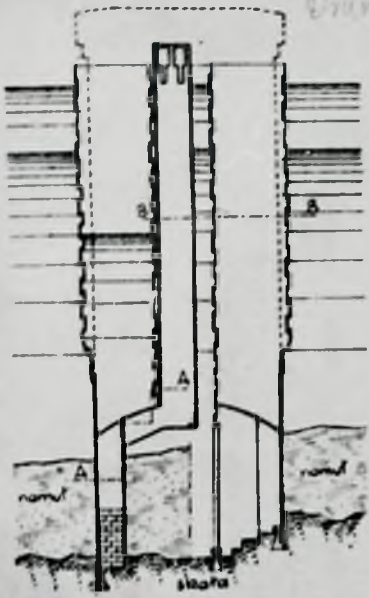

przekroj AA przekroj BB



RYS. 127

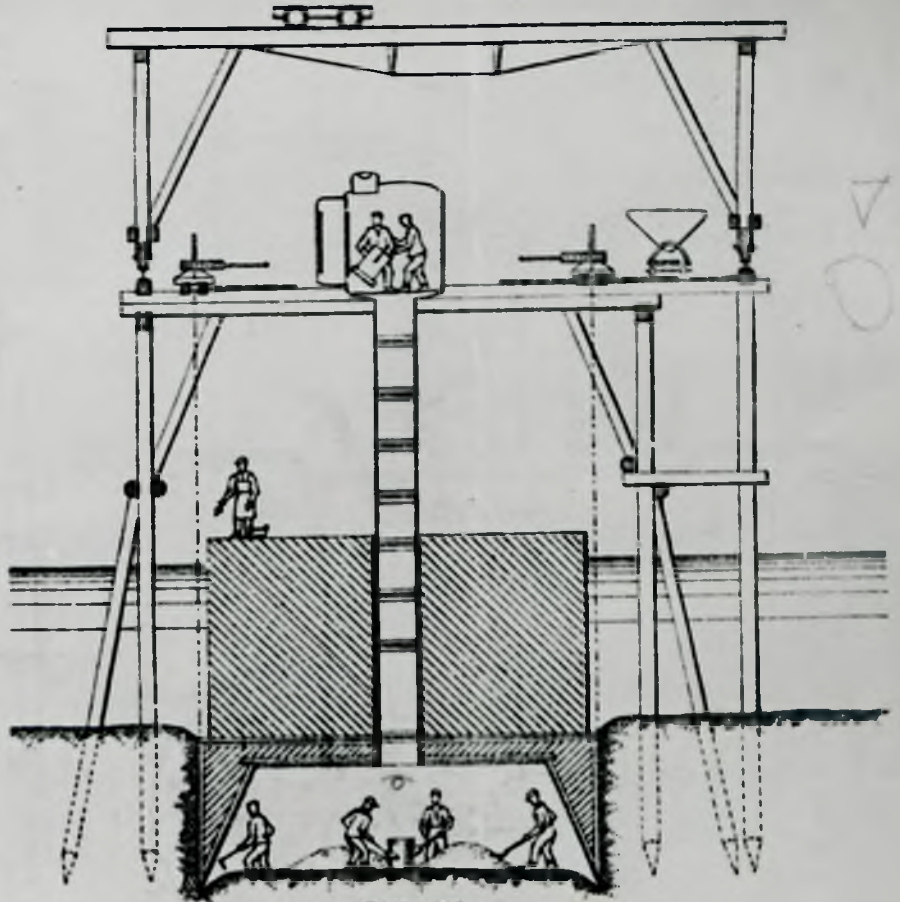

RYS. 128

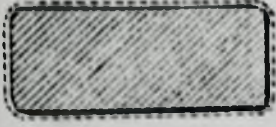

RYS. 129a

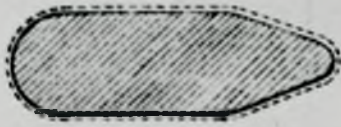

RYS. 129b

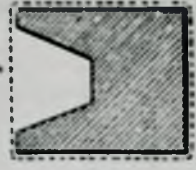

RYS. 129c

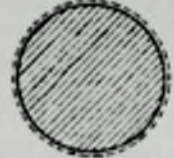

RYS. 129d

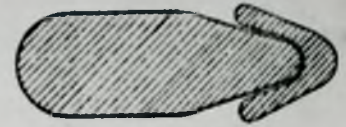

RYS. 129e

komora robocza, szyby i szluzy kesonu

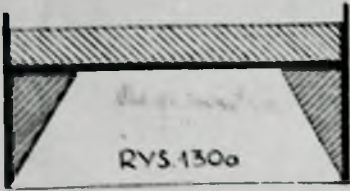

RYS. 130a

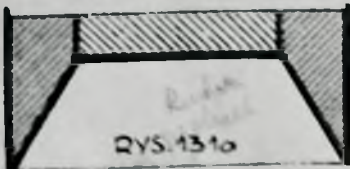

RYS. 131a

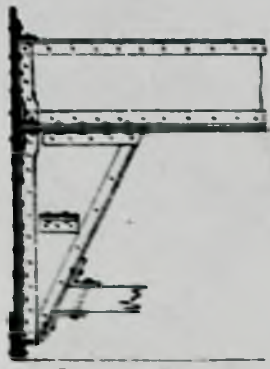

RYS. 130b

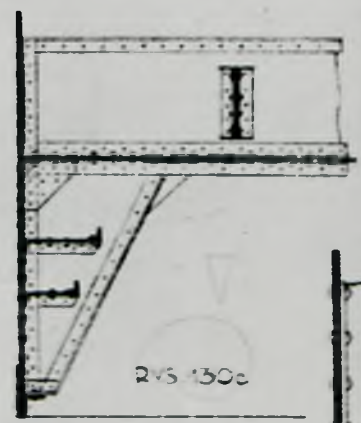

RYS. 130c

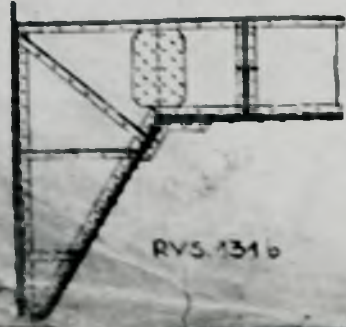

RYS. 131b

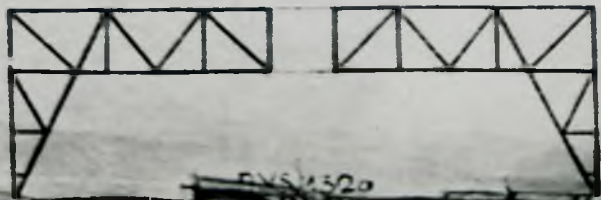

RYS. 132a



RYS. 132b

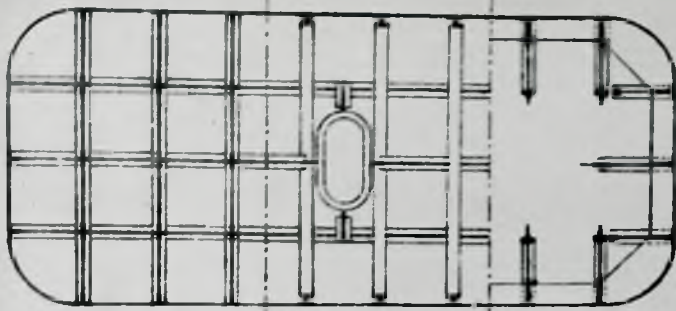

RYS. 133a

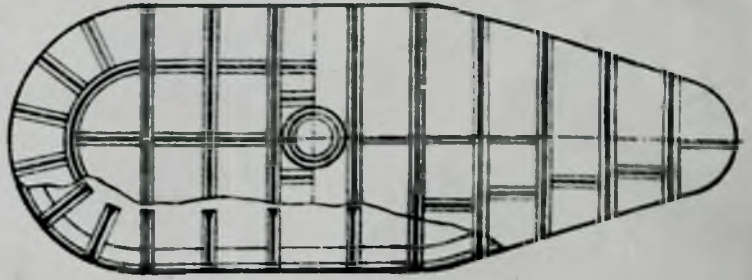
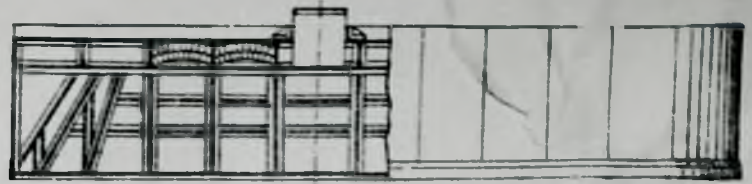

RYS. 133b



RYS. 134a

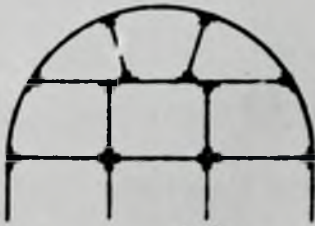

RYS. 134b

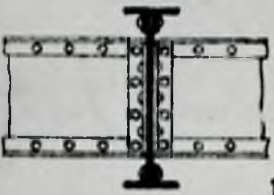

RYS. 135

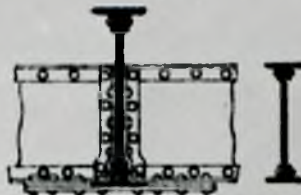

RYS. 136

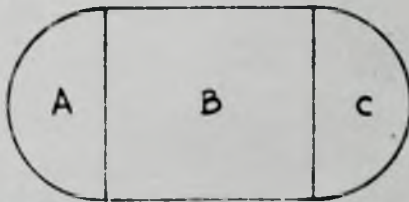
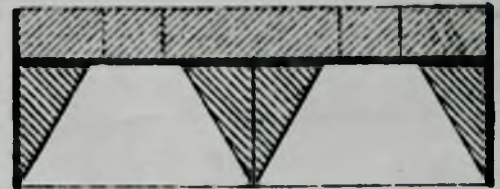

RYS. 138

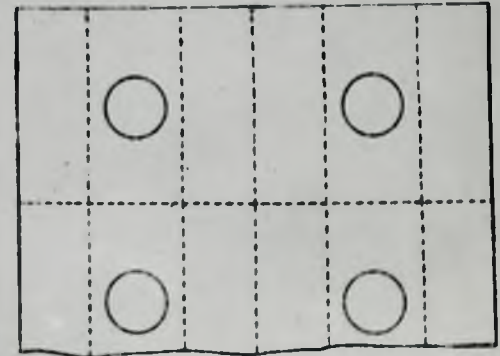
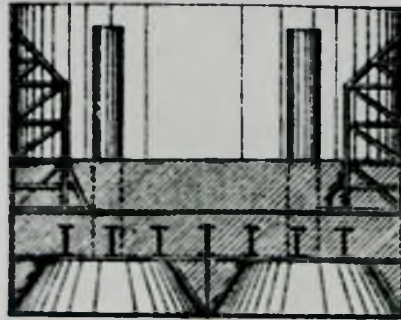

RYS. 137

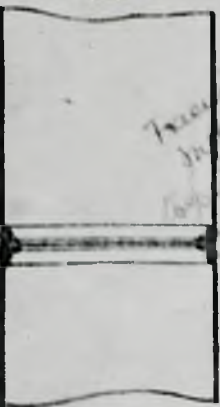

przekroj a-b

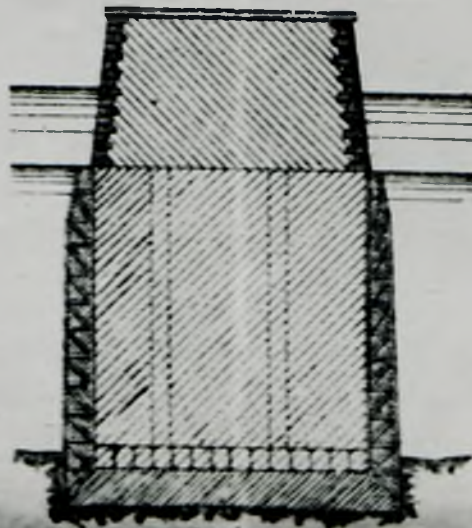
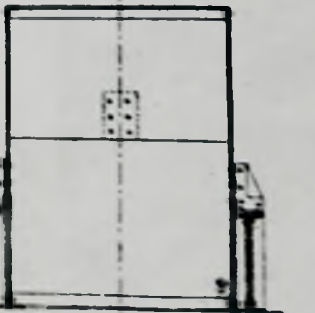

RYS. 141



RYS. 142a

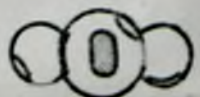
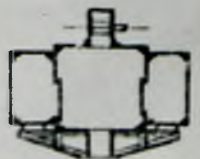

RYS. 142b 13

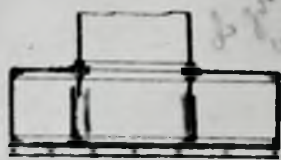

RYS 142c

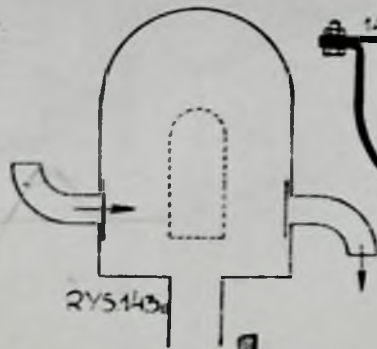

RYS 143a

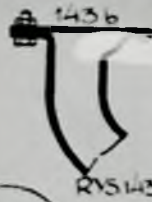

RYS 143b

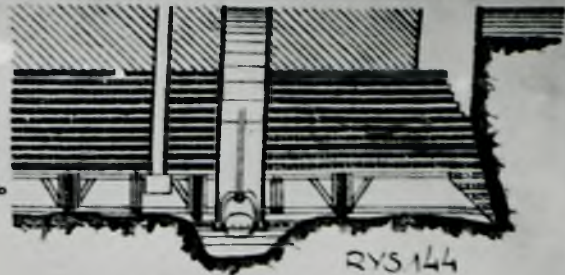

RYS 144

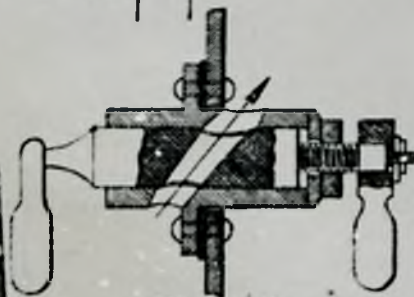

RYS. 143c



RYS. 145

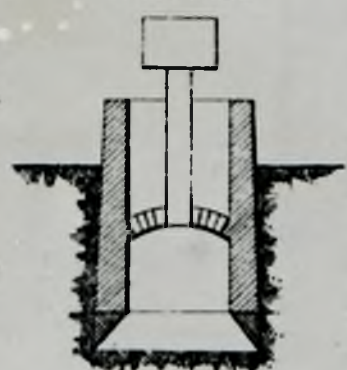
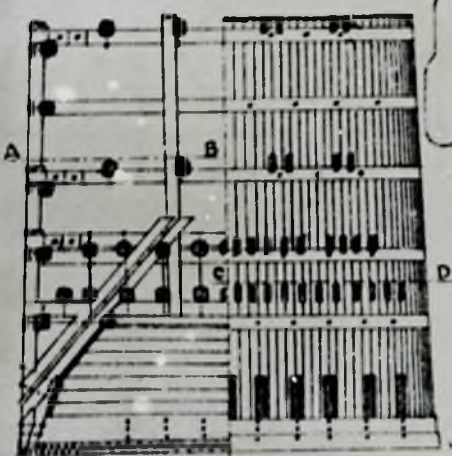

RYS 147

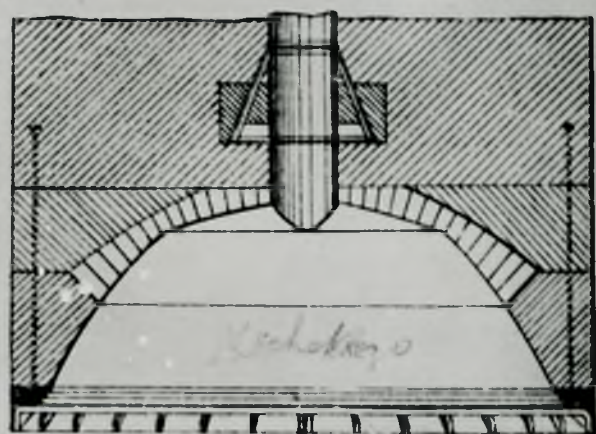

RYS. 148

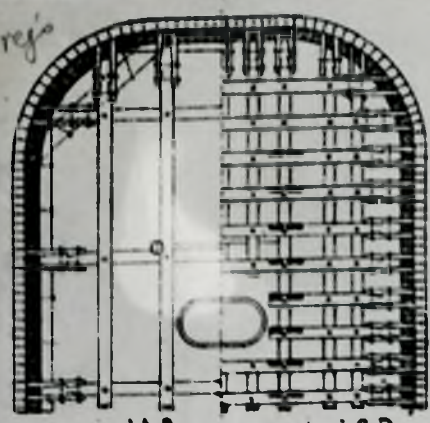

przekroj A-B przekroj C-D
RYS 146

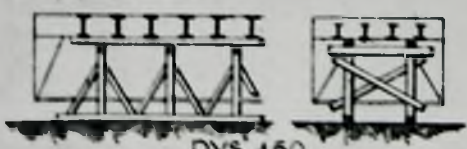

RYS. 150

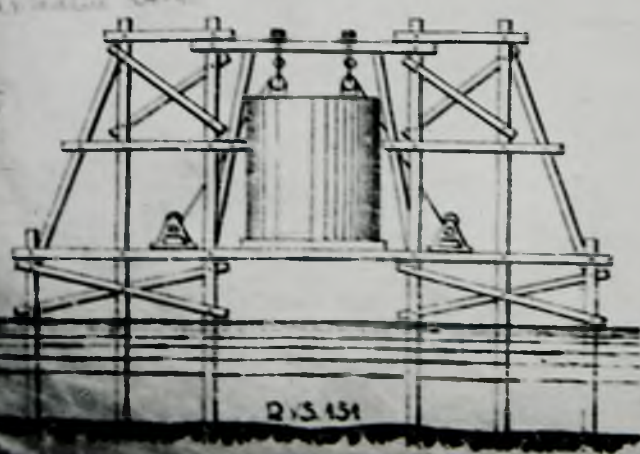

RYS 151

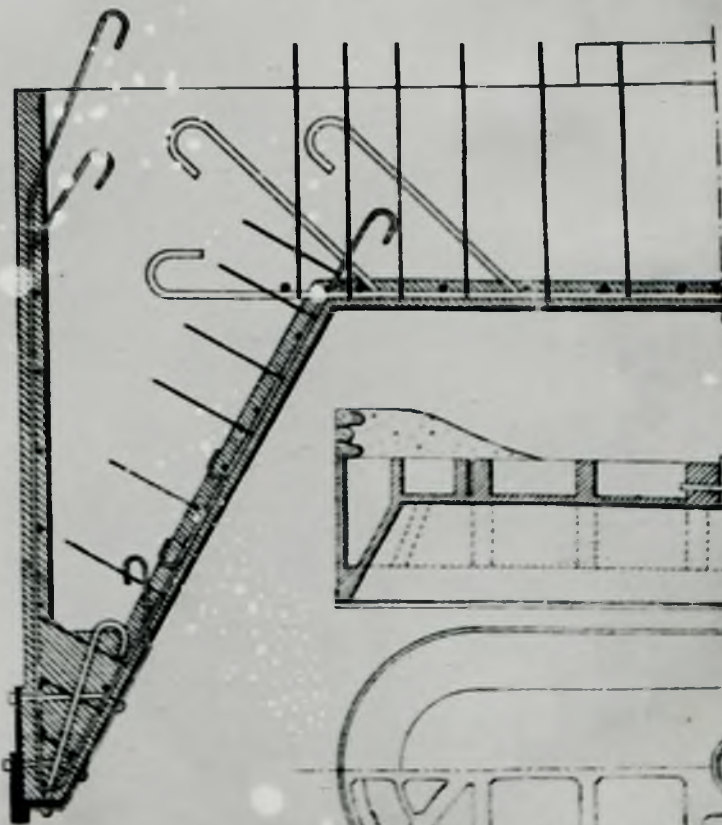

RYS. 149

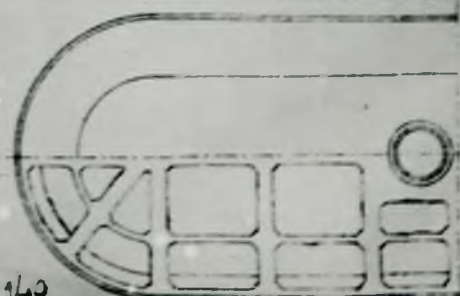
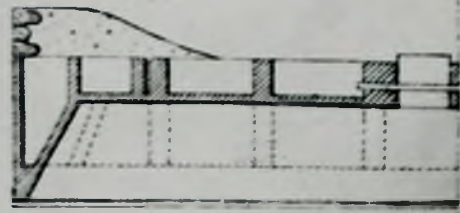

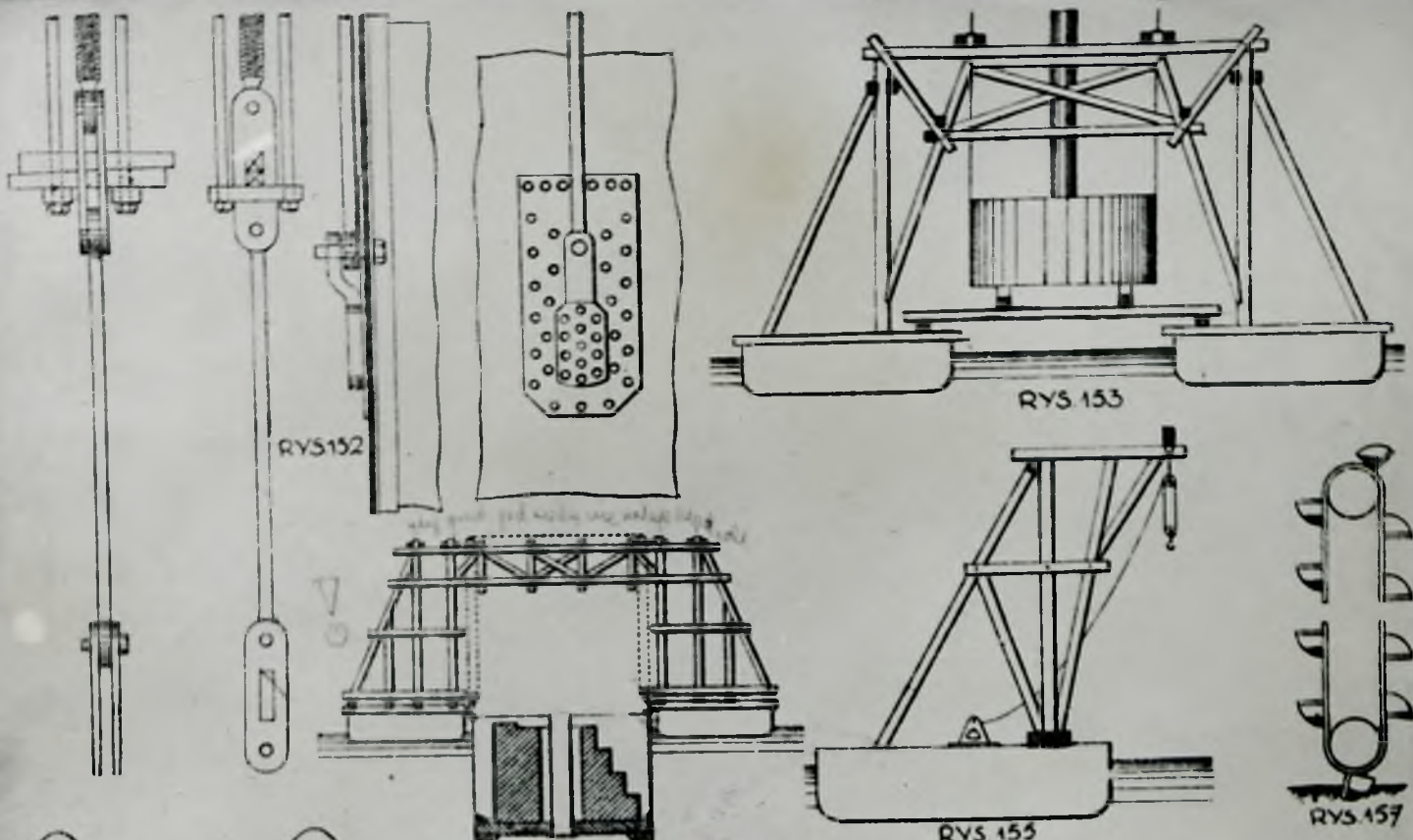

c/ kesony dzwony
 i kesony pływające

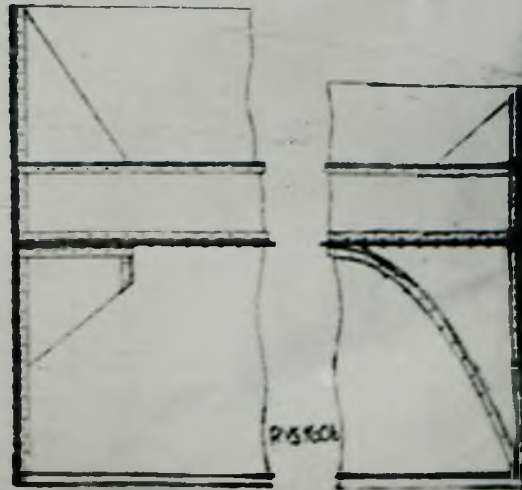
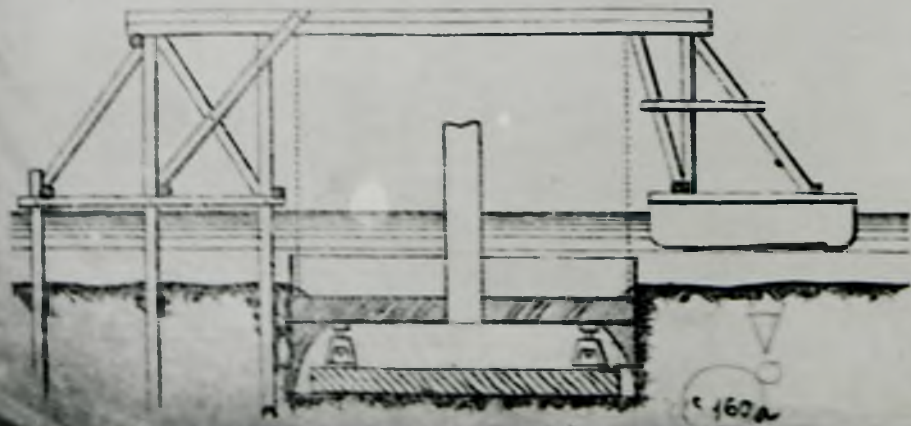
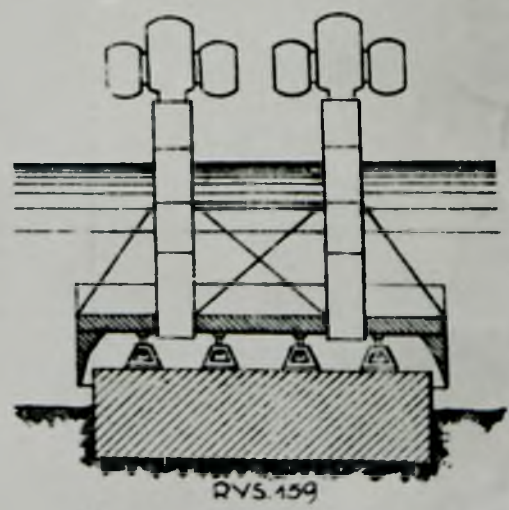
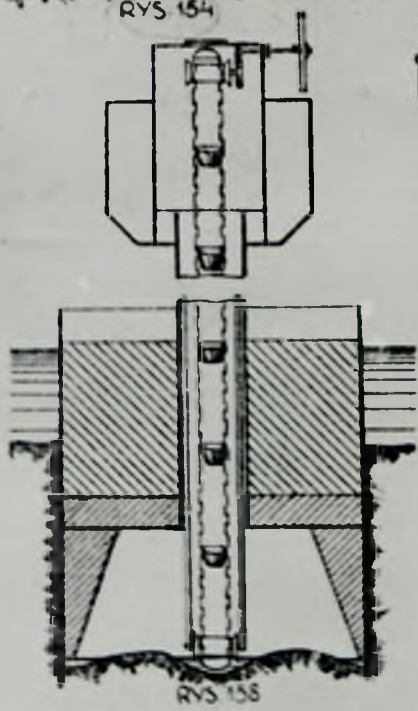
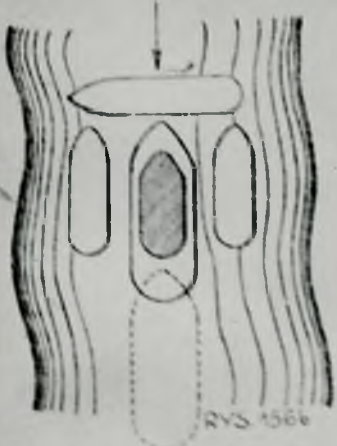
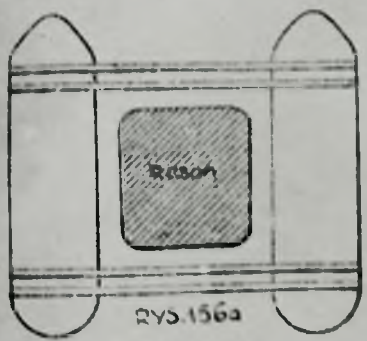

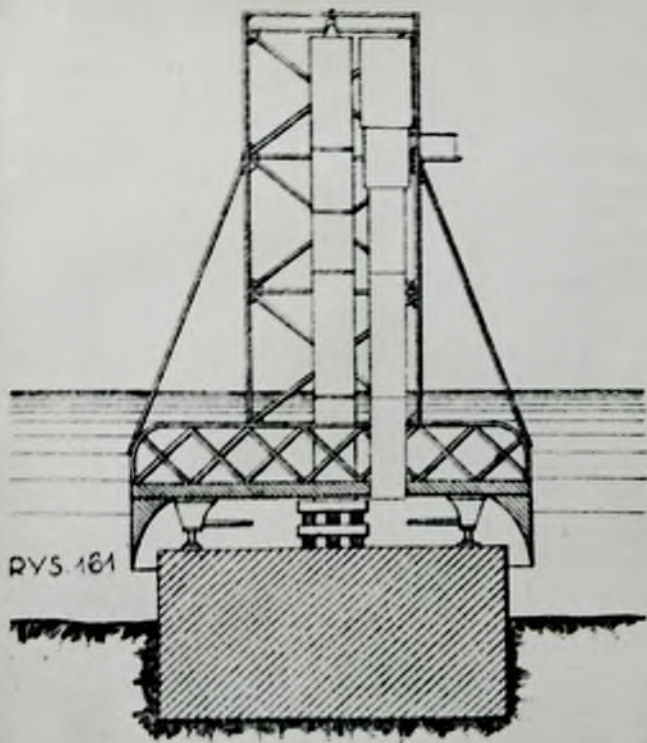

RYS. 161

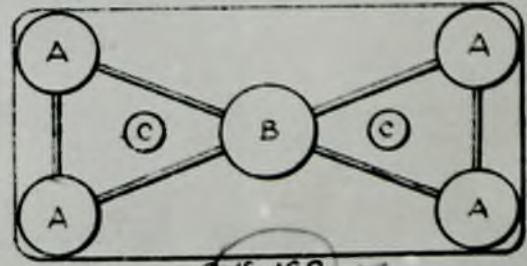
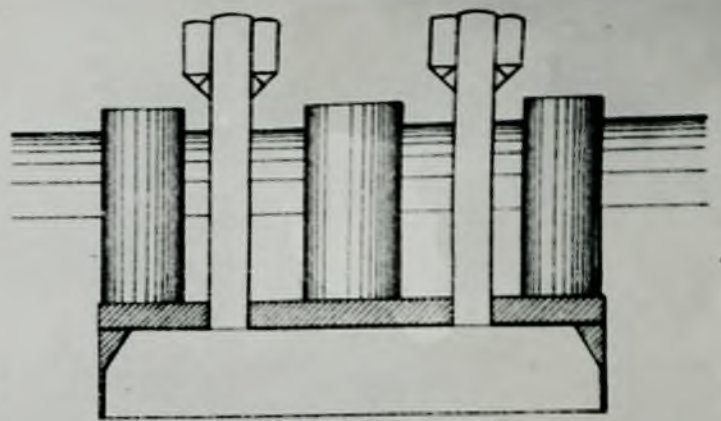

RYS. 162

A - szczyby rownowagi
 B - bania rownowagi
 C - szczyby szluzi roboczej

z. studnie zapuszczane

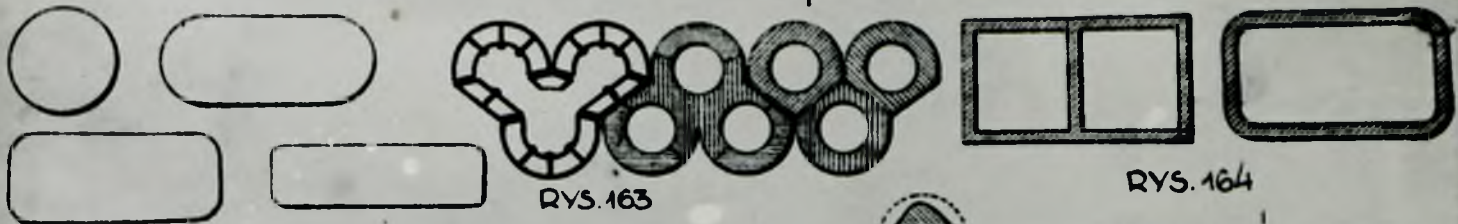

RYS. 163

RYS. 164

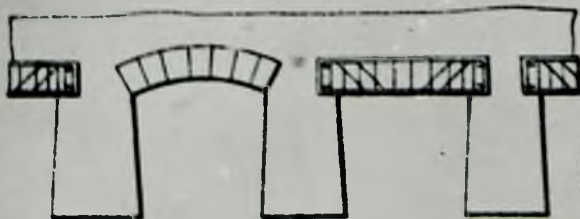

RYS. 165

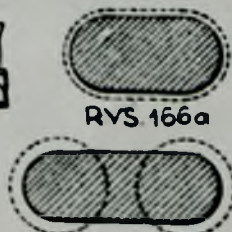

RYS. 166a

RYS. 166b



RYS. 166c

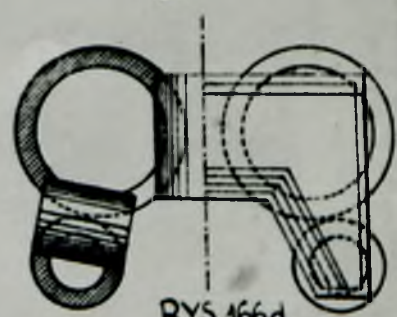

RYS. 166d

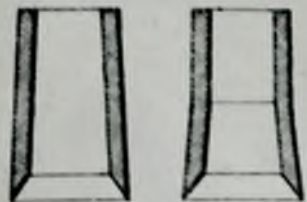

RYS. 167

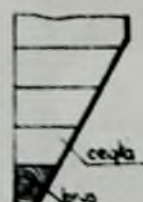

RYS. 168a



RYS. 168b



RYS. 168c



RYS. 168d



RYS. 169

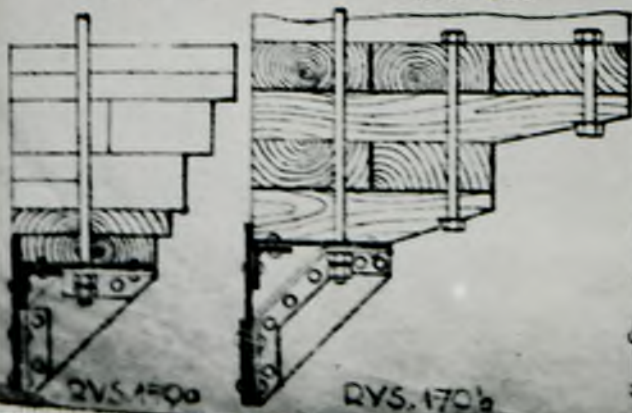

RYS. 170a

RYS. 170b

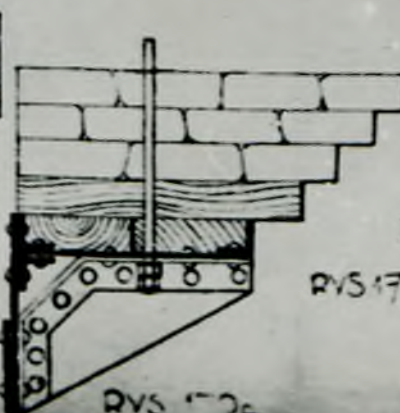

RYS. 170c

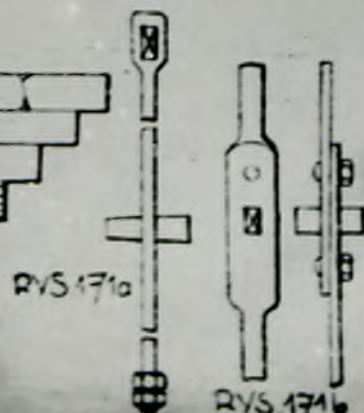

RYS. 171a

RYS. 171b



RYS. 171c

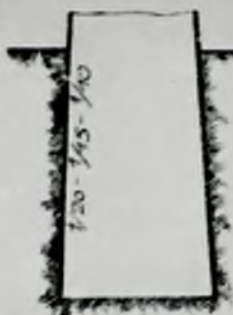

RYS. 172



RYS. 173

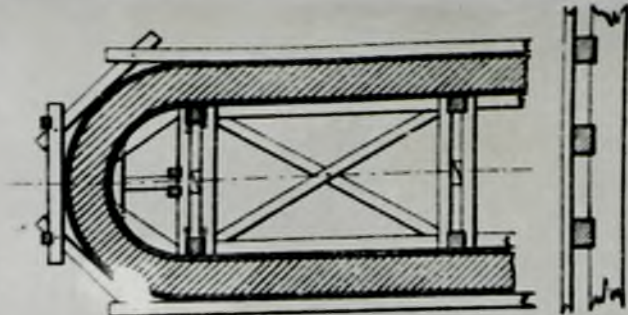

RYS. 174



RYS. 175



RYS. 176

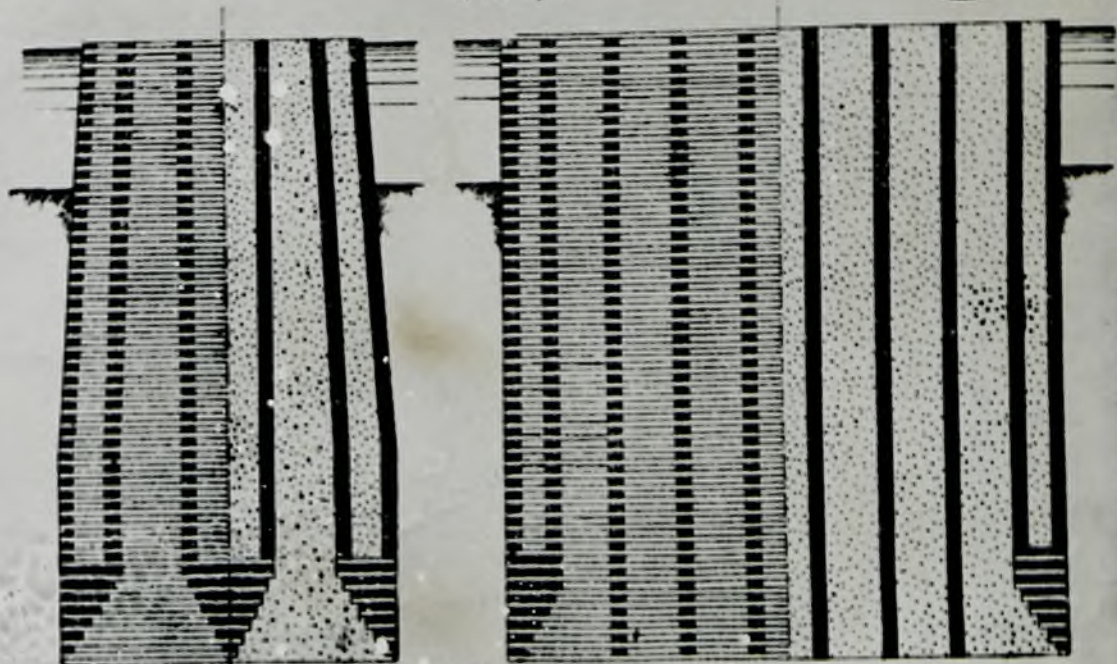

RYS. 177

W - sztyby robocze

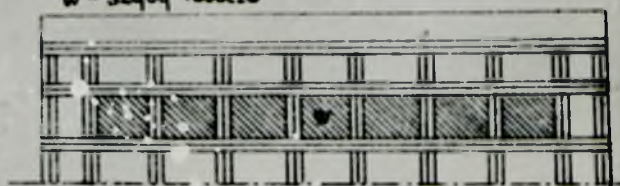

RYS. 178

RYS. 178

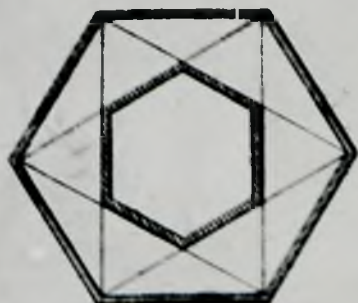

RYS. 179

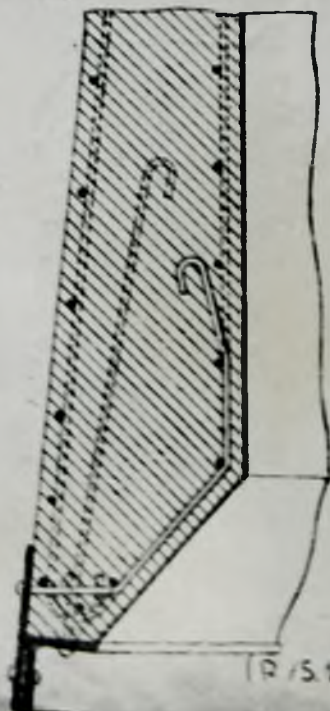
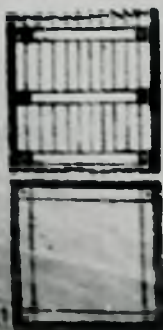

RYS. 180

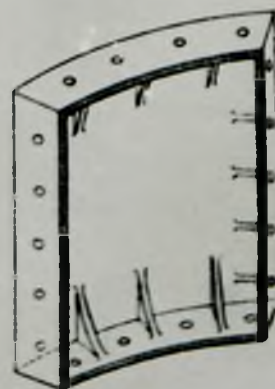
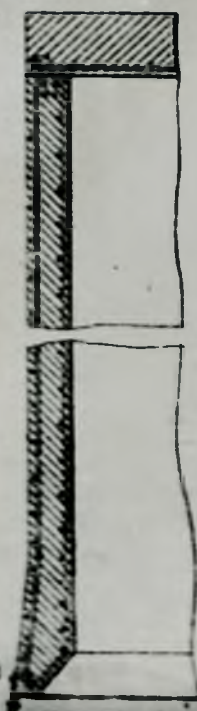

RYS. 182



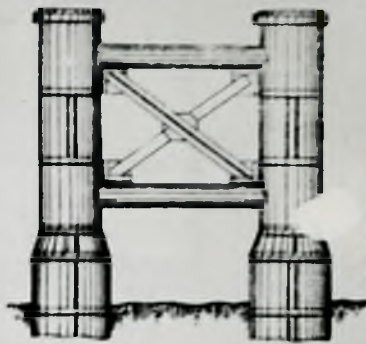

RYS 184

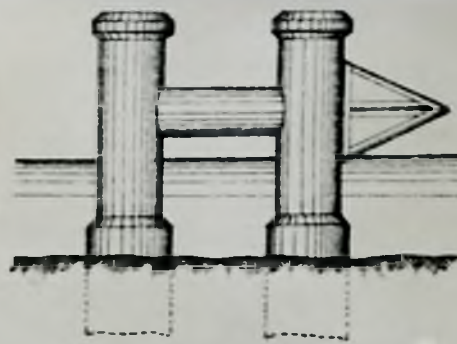

RYS 185

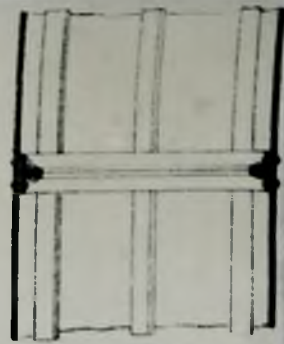

RYS 183

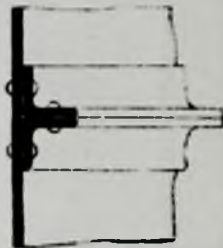

RYS 187a



RYS 187b



RYS 187c



RYS 186

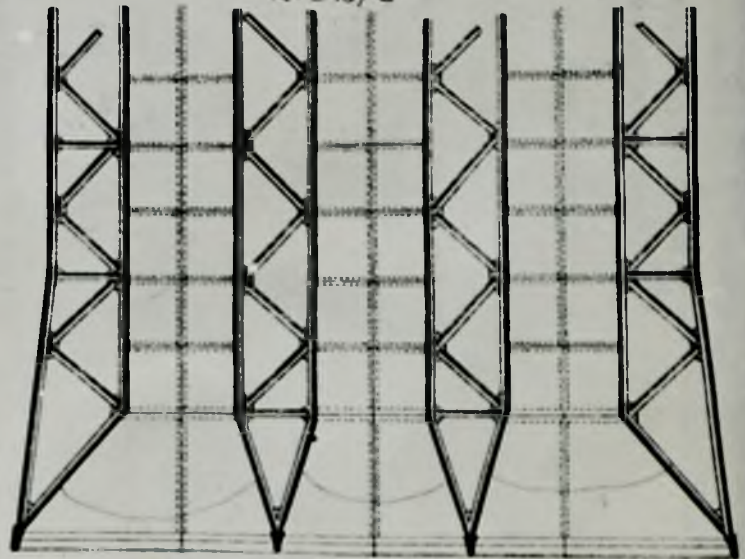
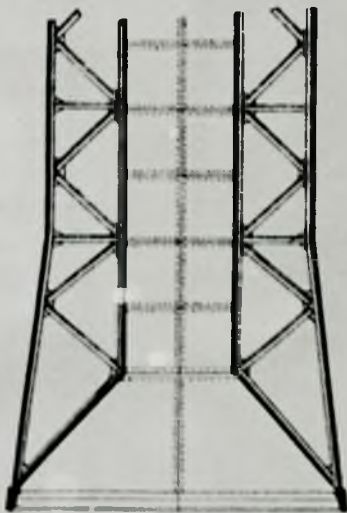

RYS 188

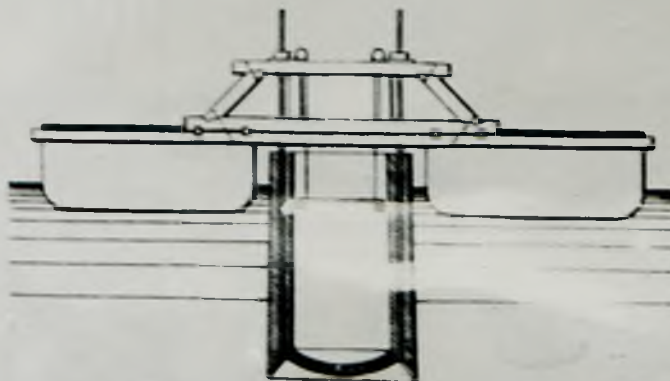
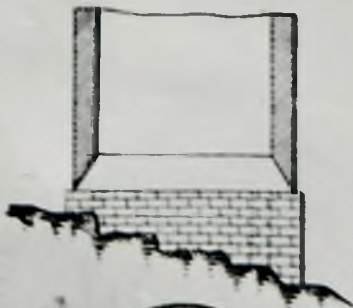
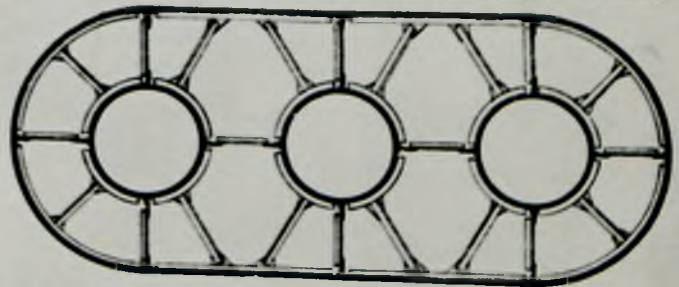

RYS 191

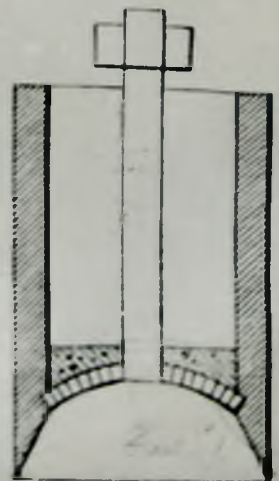

RYS 102



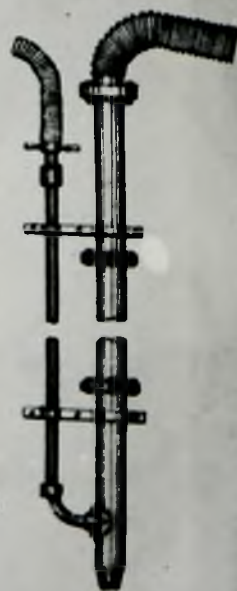
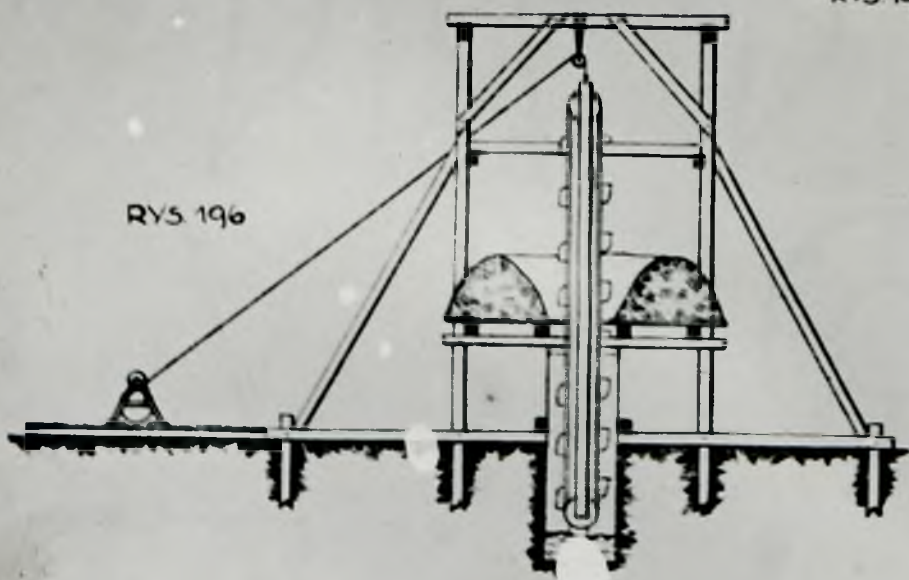
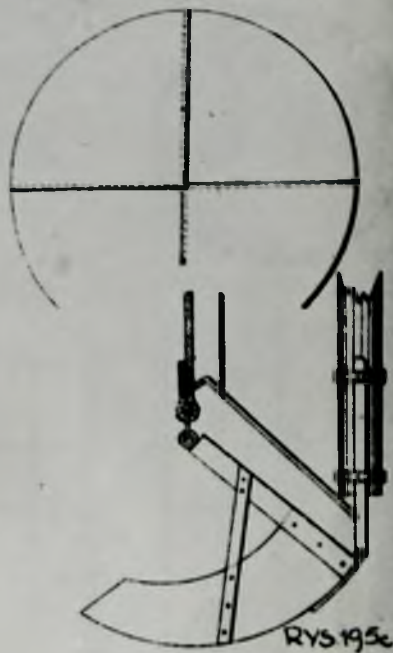
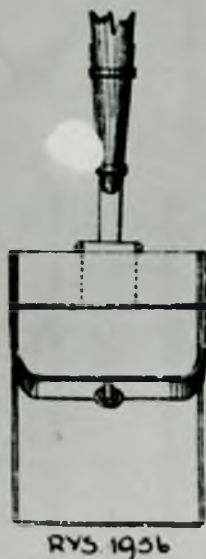
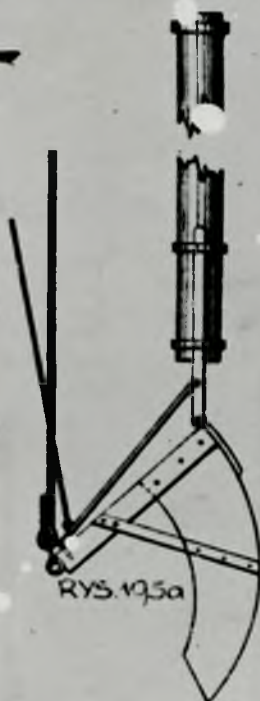
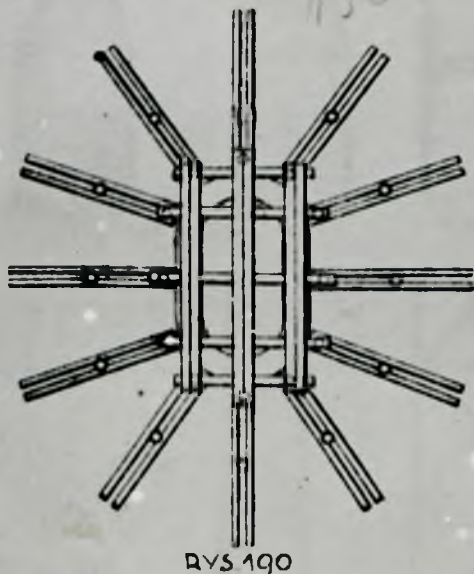
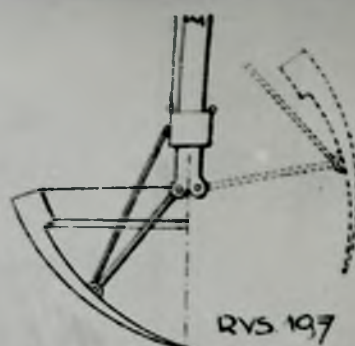
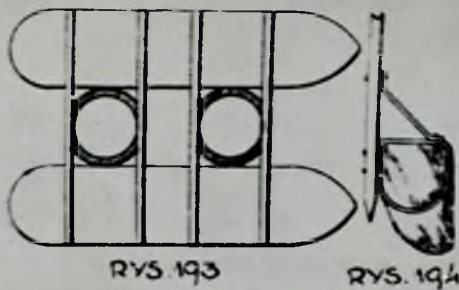
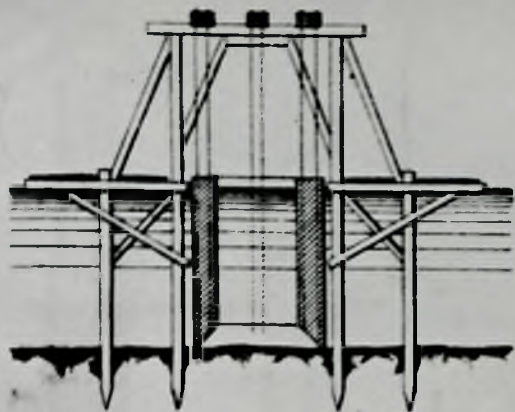

XI. fundamentowanie na gruntach skalnych

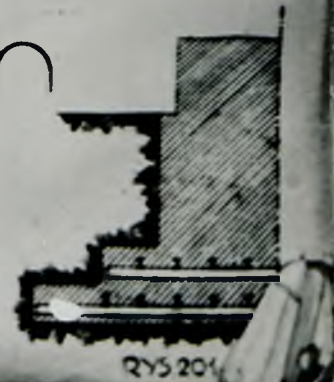
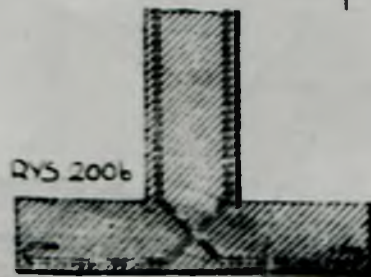
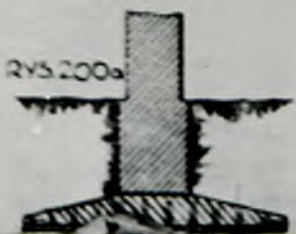
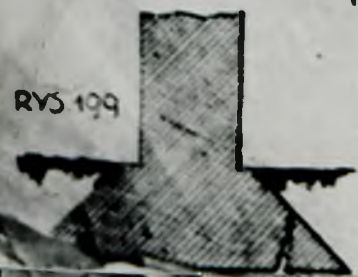



RYS.214

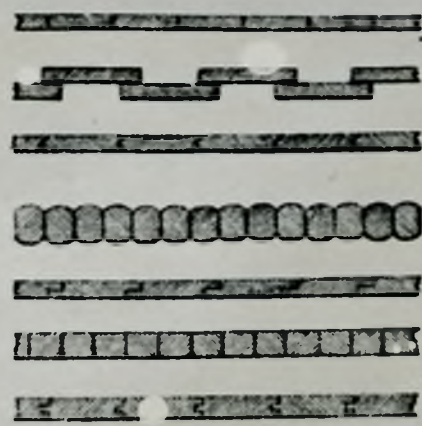
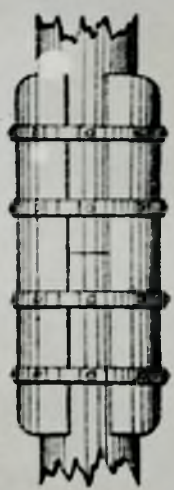
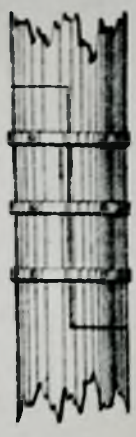

RYS.216a
RYS.216b
RYS.216c
RYS.217a
RYS.217b
RYS.217c
RYS.217d

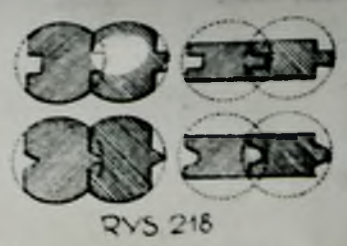

RYS.218



RYS.219a

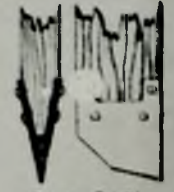

RYS.219b



RYS.215



RYS.222b



RYS.224a

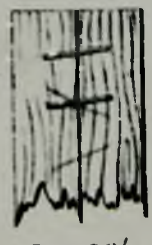

RYS.224c



RYS.220



RYS.221



RYS.222a

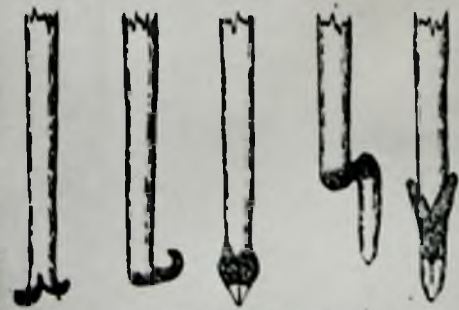

RYS.225 a,b,c,d,e

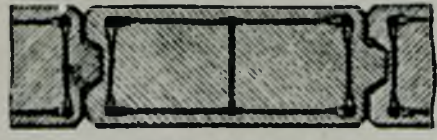

RYS.228a



RYS.228b

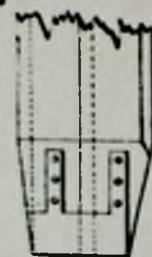
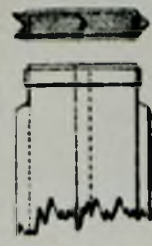

RYS.224c

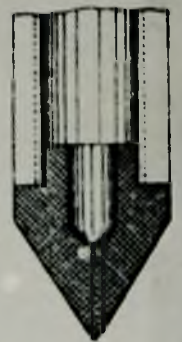

RYS.223



RYS.230



RYS.227



RYS.226



RYS.231

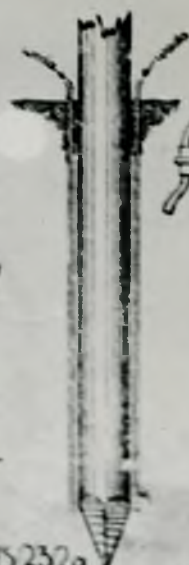

RYS.232a

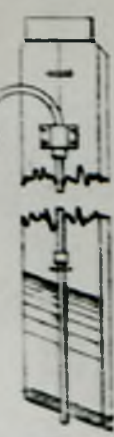

RYS.232b

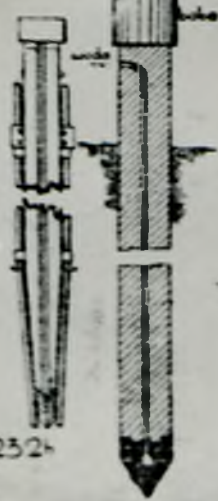

RYS.232c



RYS.233

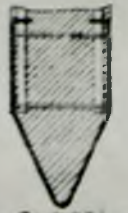

RYS.234

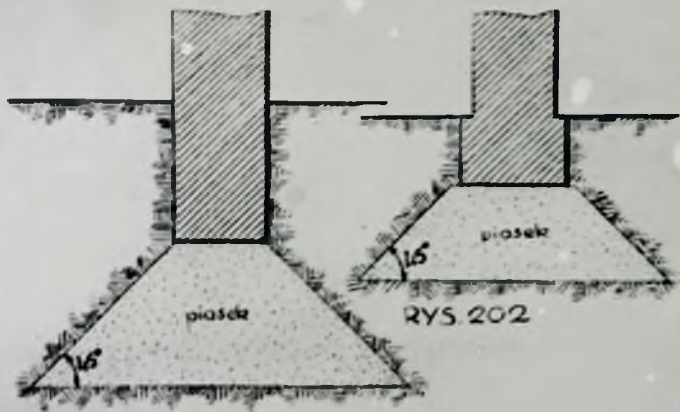

RYS. 202

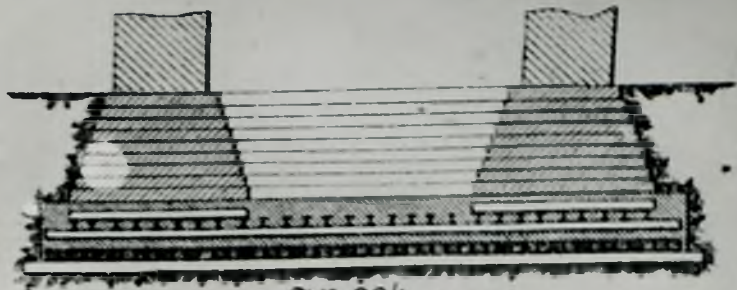

RYS. 204

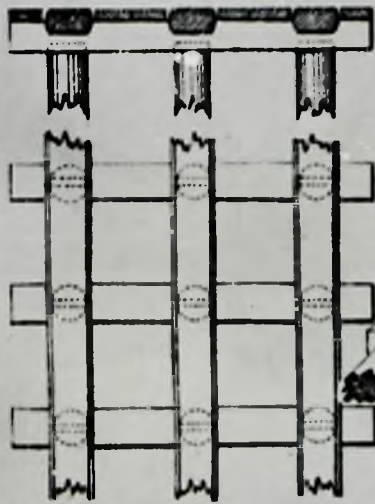

RYS. 203

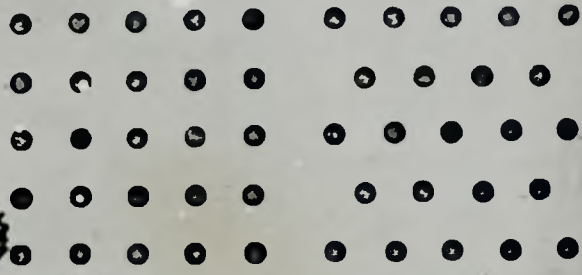
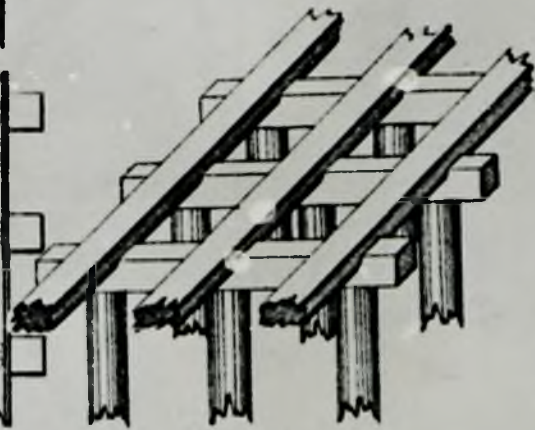

RYS. 205a

RYS. 205b

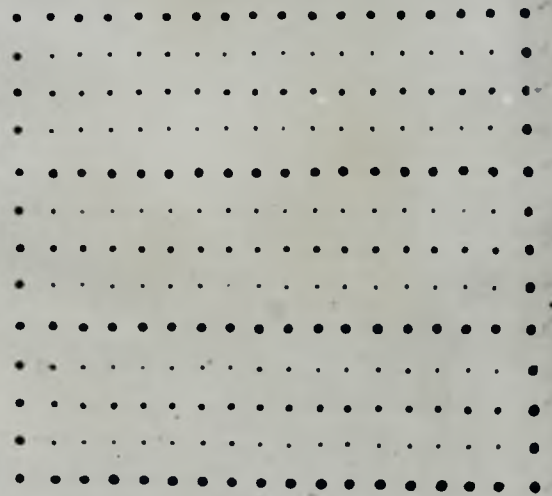

RYS. 205c

XII. pale

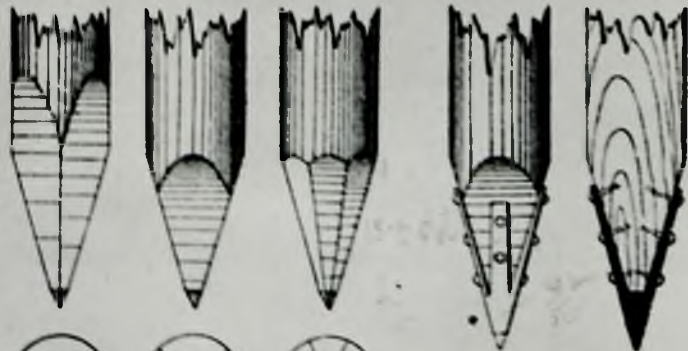

RYS. 208a



RYS. 207a RYS. 207b RYS. 207c



RYS. 208b



RYS. 208c

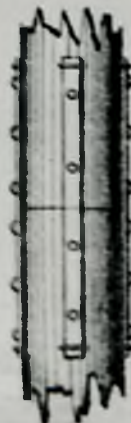

RYS. 210a

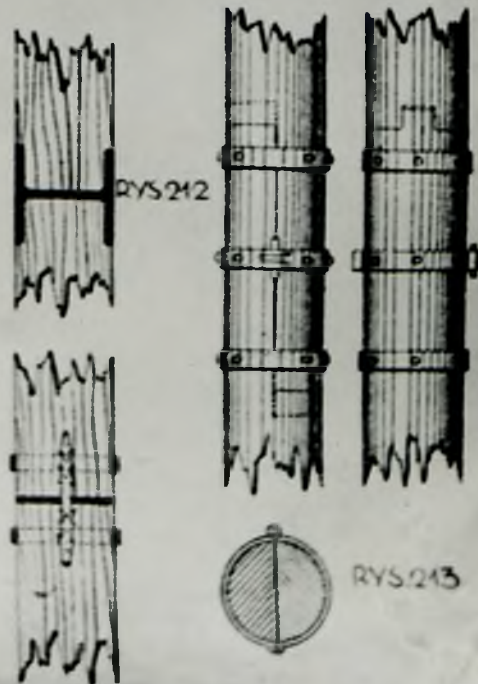

RYS. 212

RYS. 211b

RYS. 213



RYS. 235

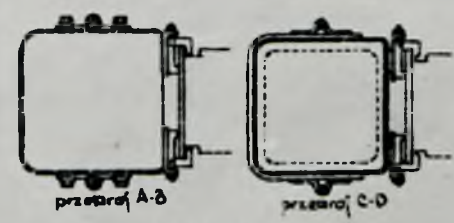
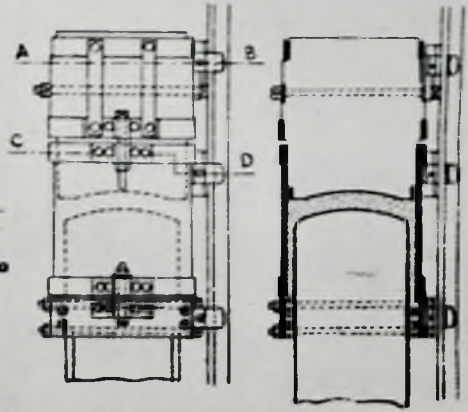

RYS. 236

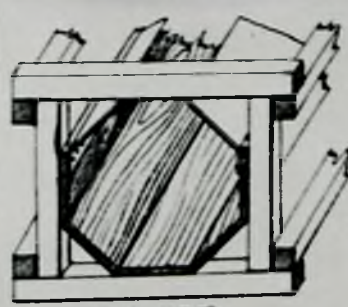

RYS. 237

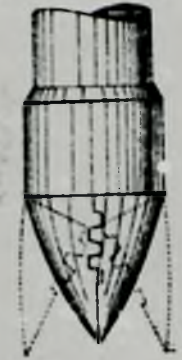

RYS. 239b

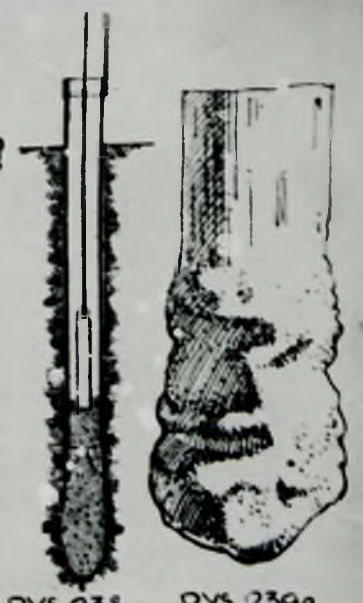

RYS. 238

RYS. 239a



RYS. 240

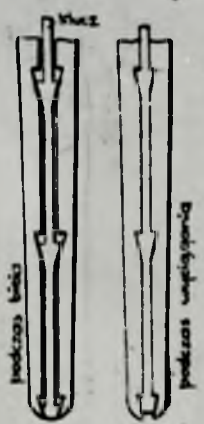

RYS. 241

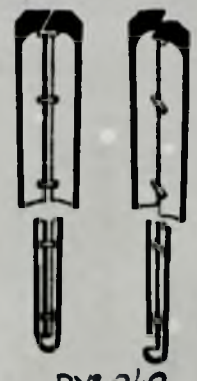

RYS. 242

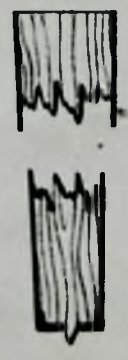

RYS. 243

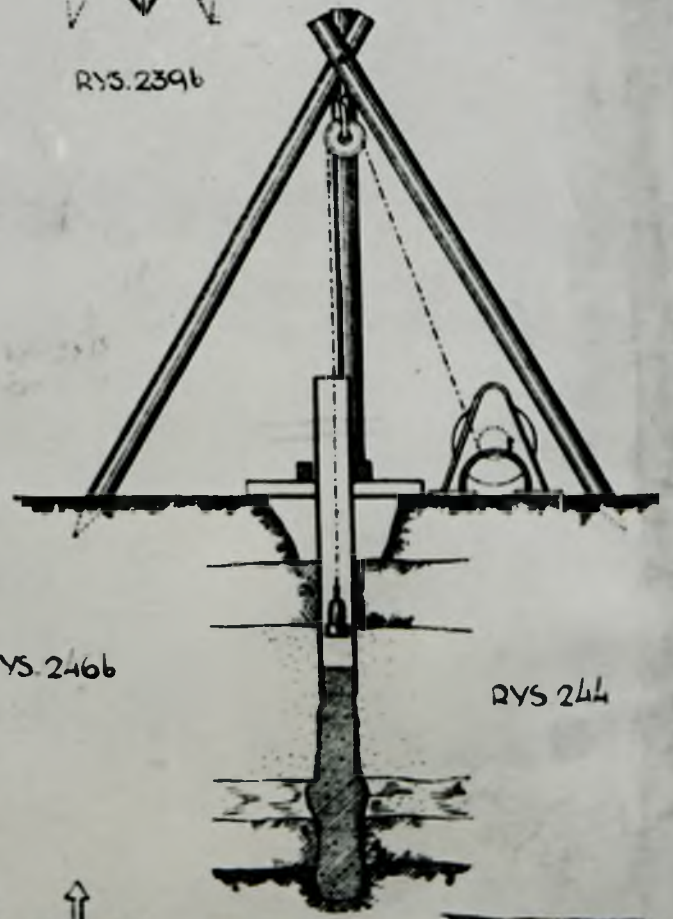

RYS. 244



RYS. 243a

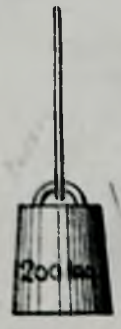

RYS. 245b

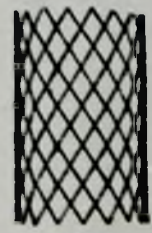

RYS. 240a



RYS. 246b



RYS. 248



RYS. 249



RYS. 249b



RYS. 249d



RYS. 250a

RYS. 250b

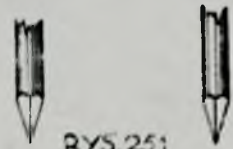
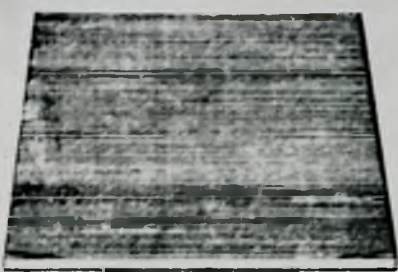

RYS 251



RYS 253



RYS 254

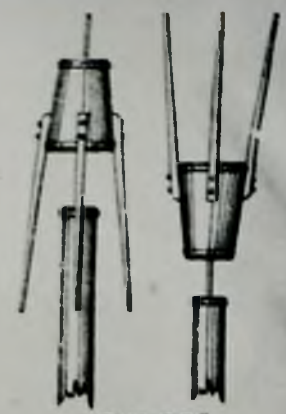

RYS 255

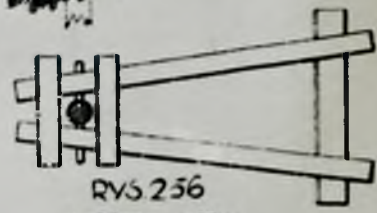

RYS 256

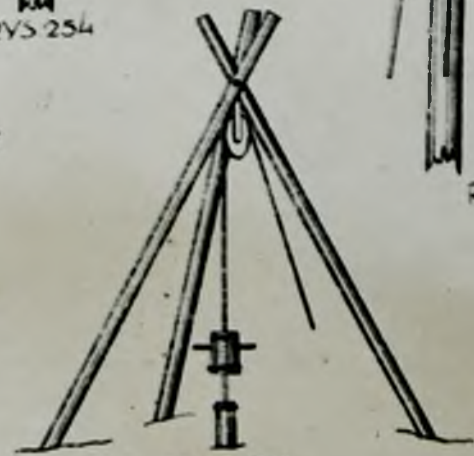

RYS 257

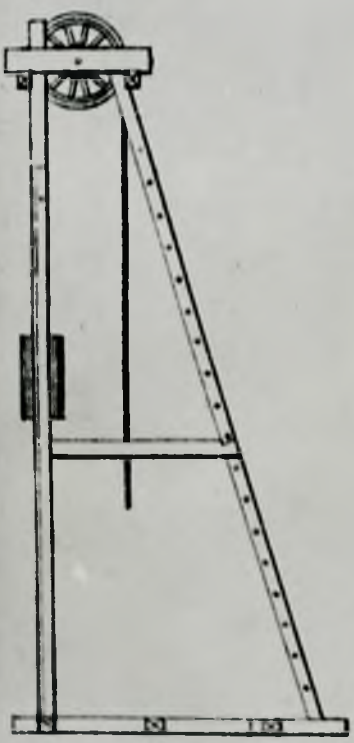

RYS 258

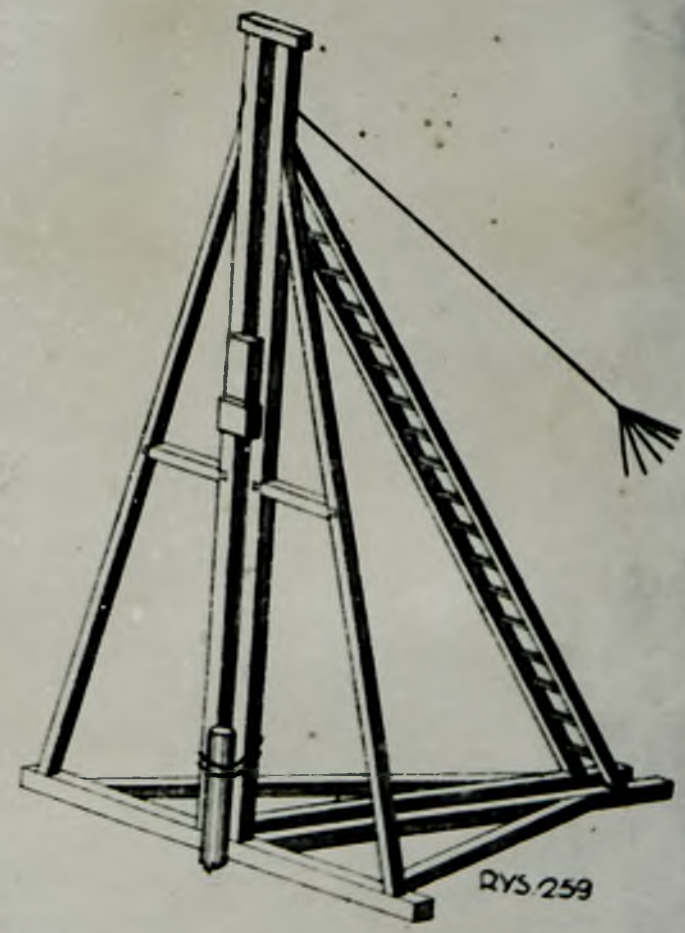

RYS 259

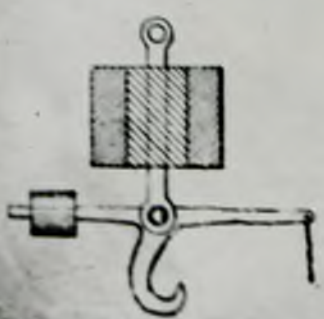
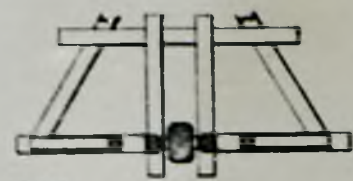
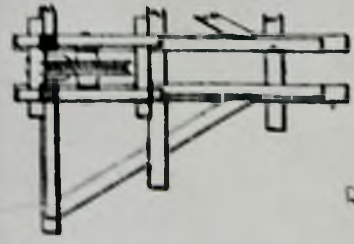

RYS 261

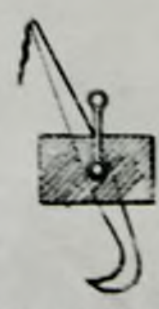

RYS 261

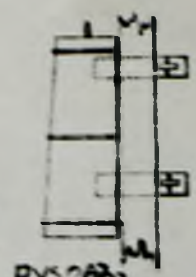

RYS 263a

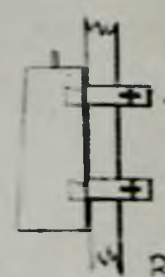

RYS 263b

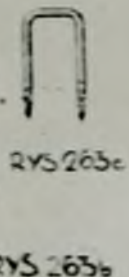

RYS 264



RYS 264b



RYS 264c

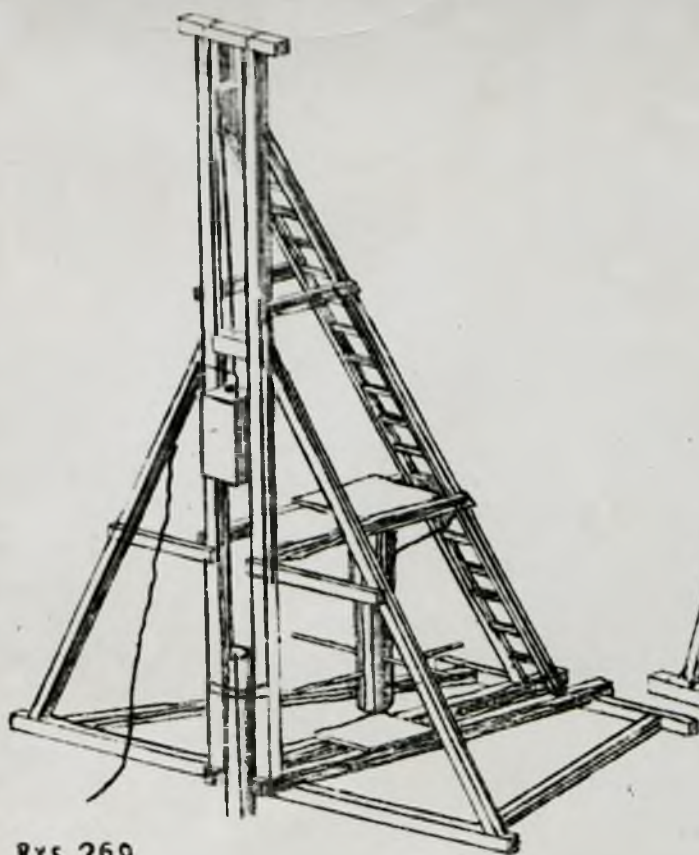

RYS 260

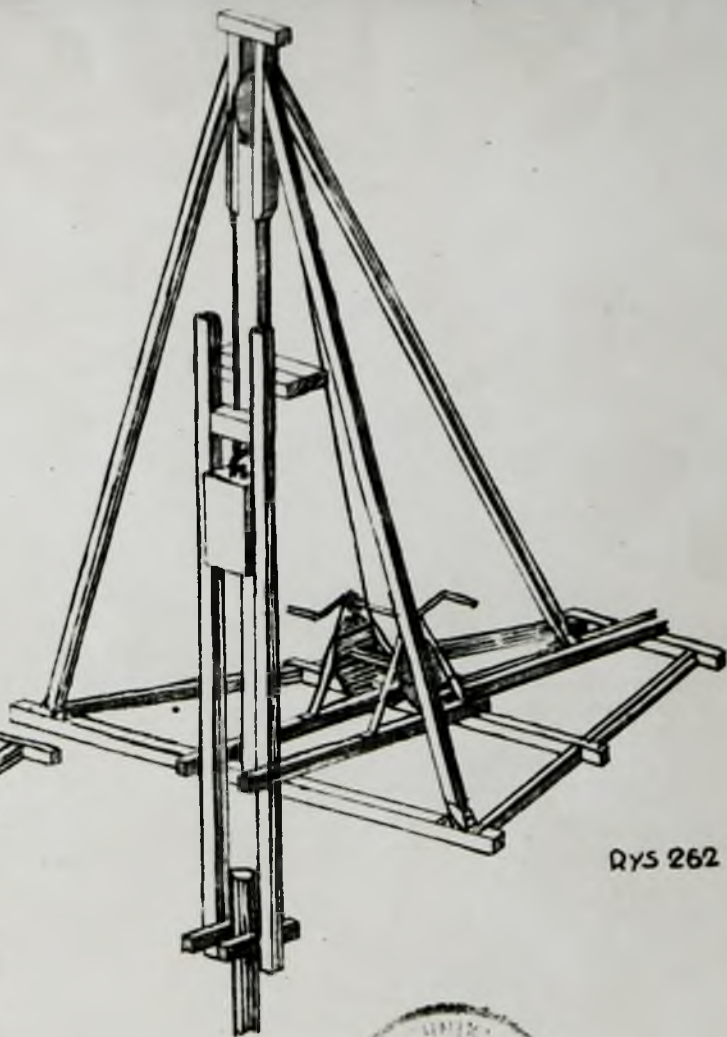

RYS 262



RYS 265a



RYS 265b

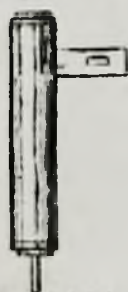

RYS 265d

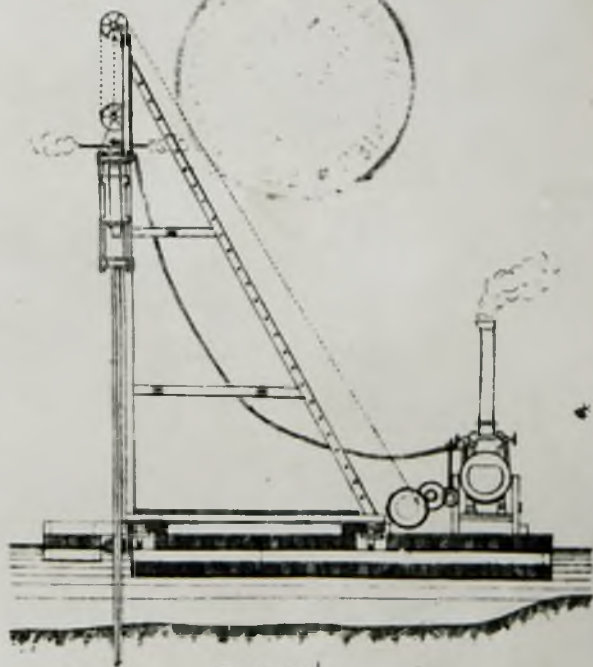

RYS 264



RYS 266a

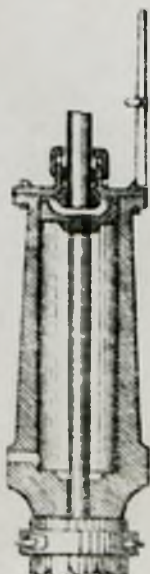

RYS 266b

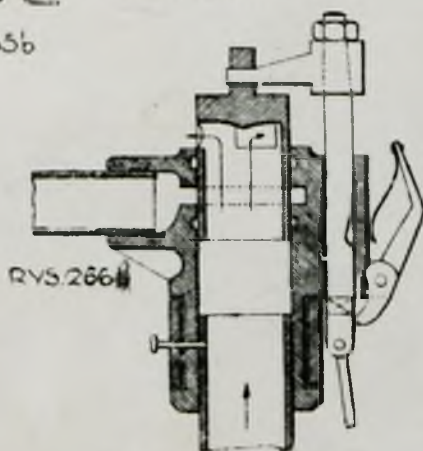

RYS 266c

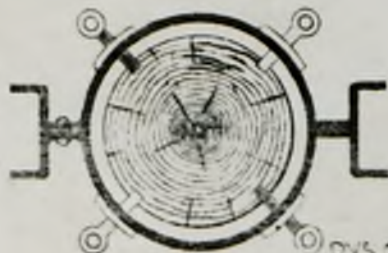

RYS 266e