

KOMISJA WYDAWNICZA  
Towarzystwa Bratniej Pomocy Studentów Politechniki Warszawskiej

---

Inż.-elektr. **ROMAN TREHCIŃSKI**  
Profesor Politechniki Warszawskiej

# SCHEMATY TELEFONICZNE



Nr wyd. 265.



Warszawa

1938 r.

---

Wydano wspólnie z Kołem Elektryków Studentów Politechniki Warszawskiej

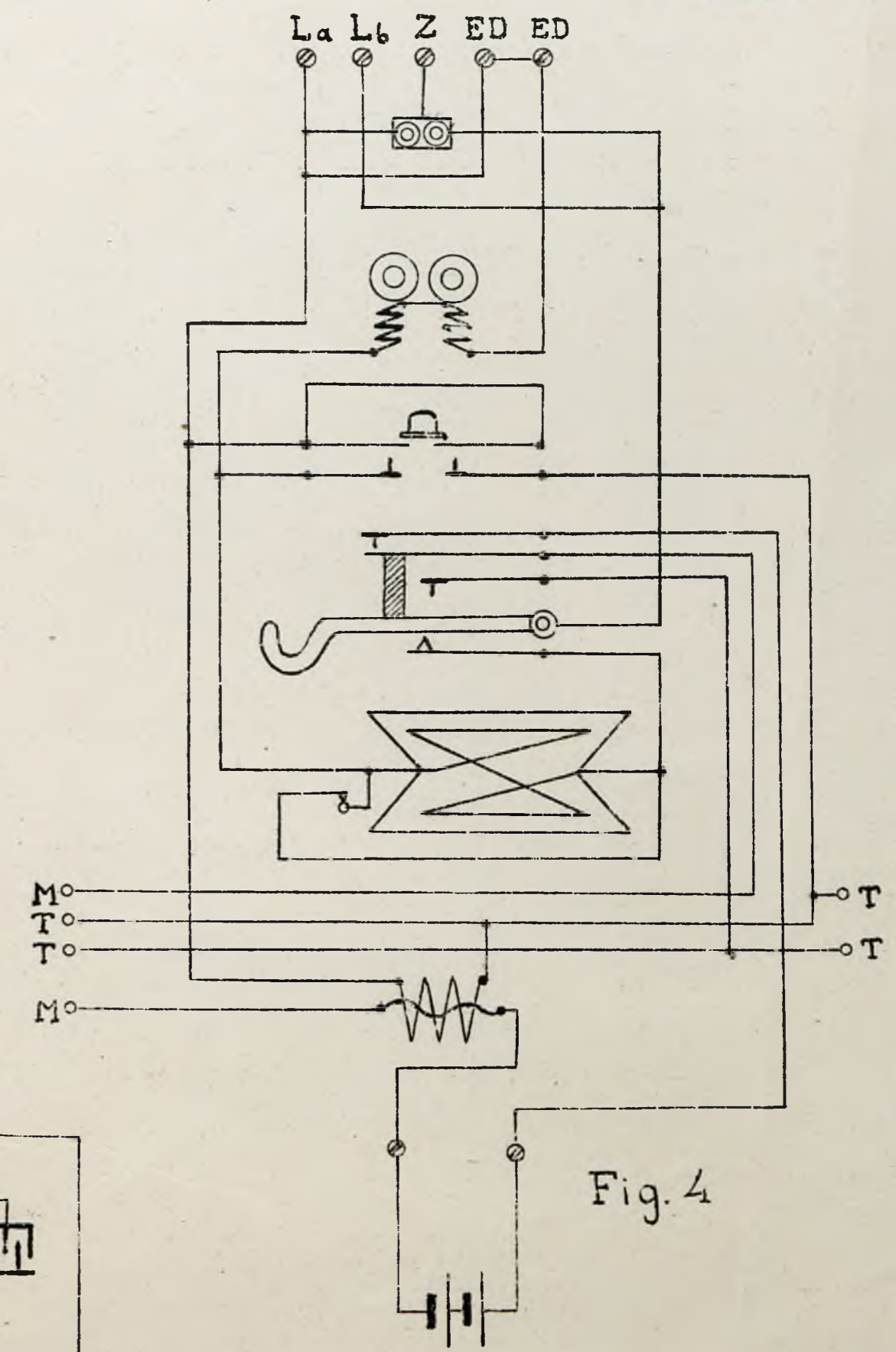
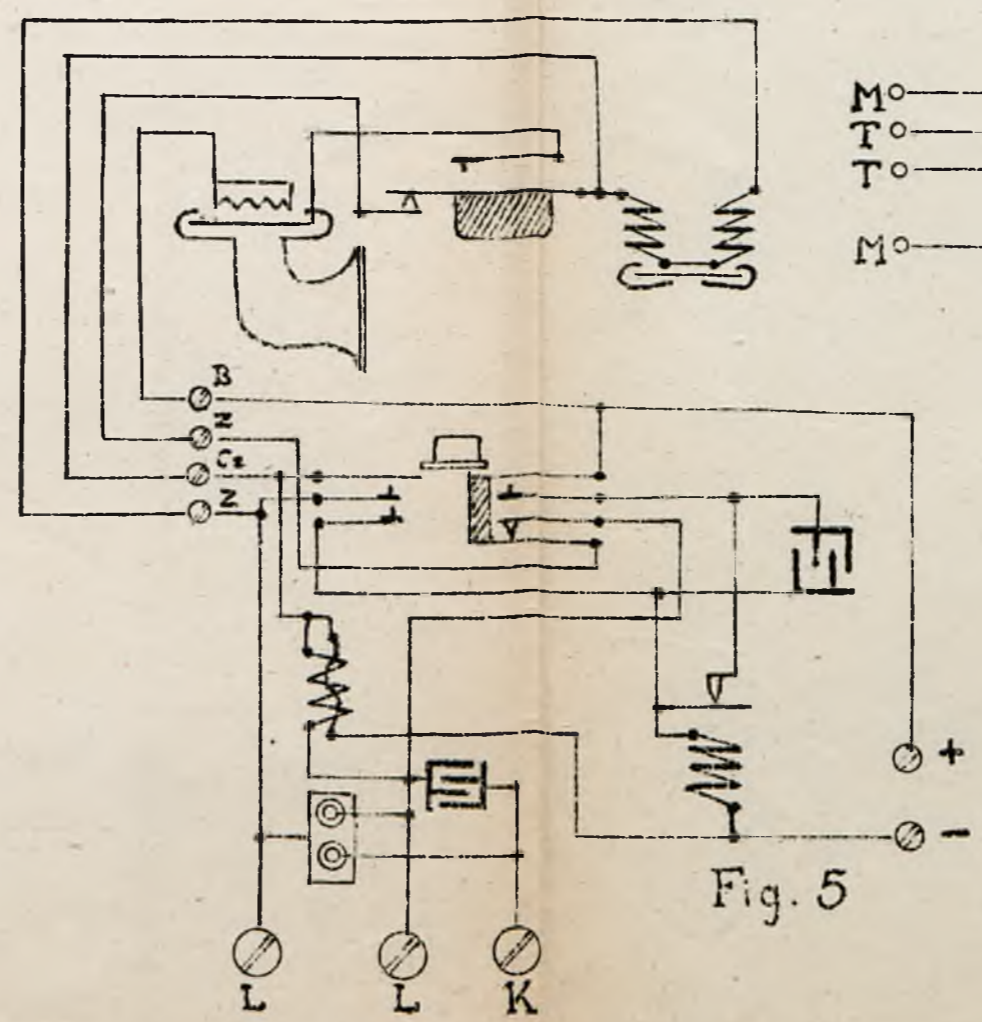
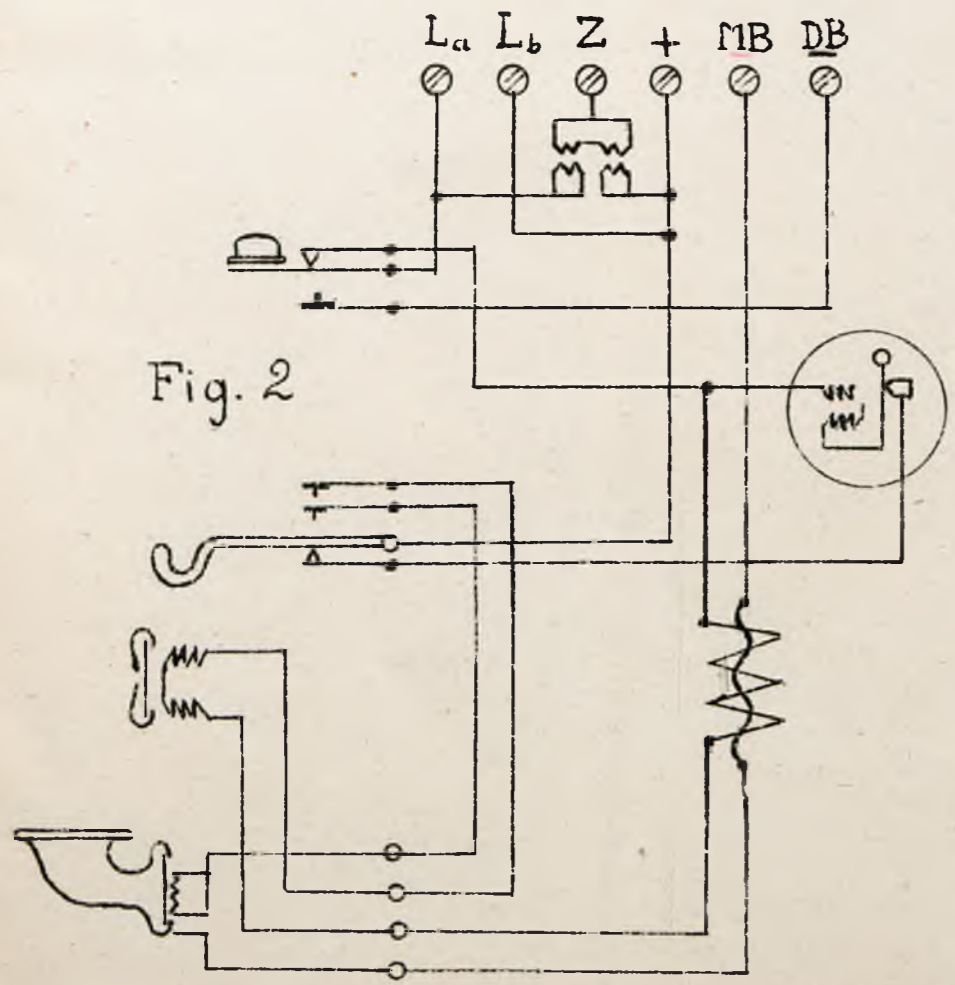
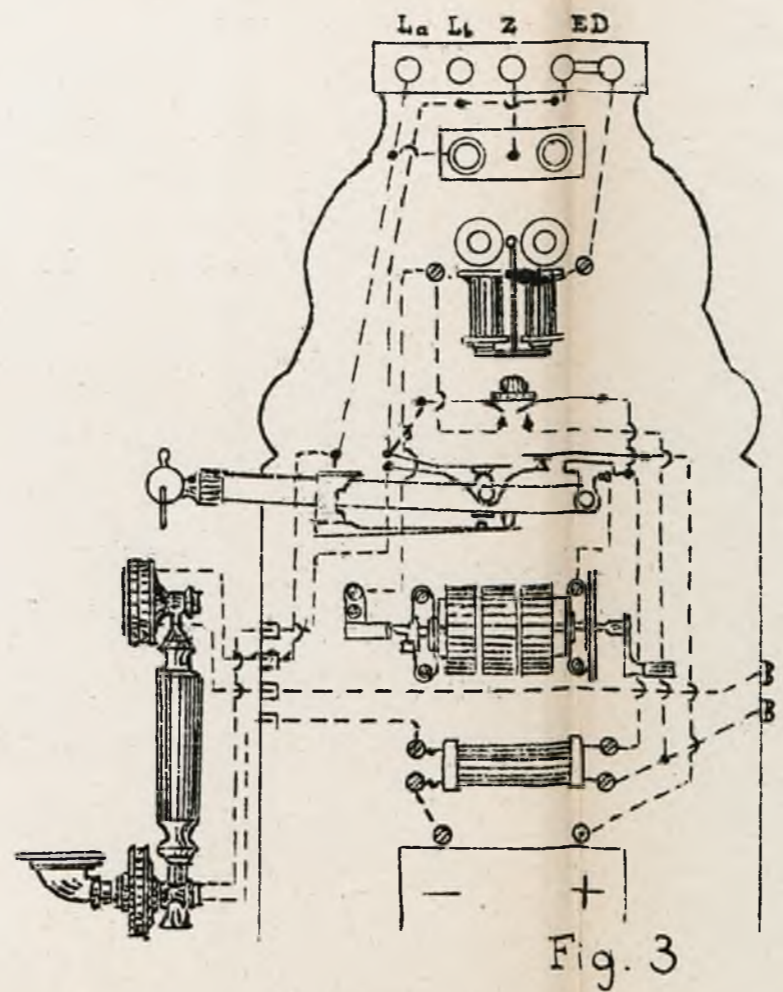
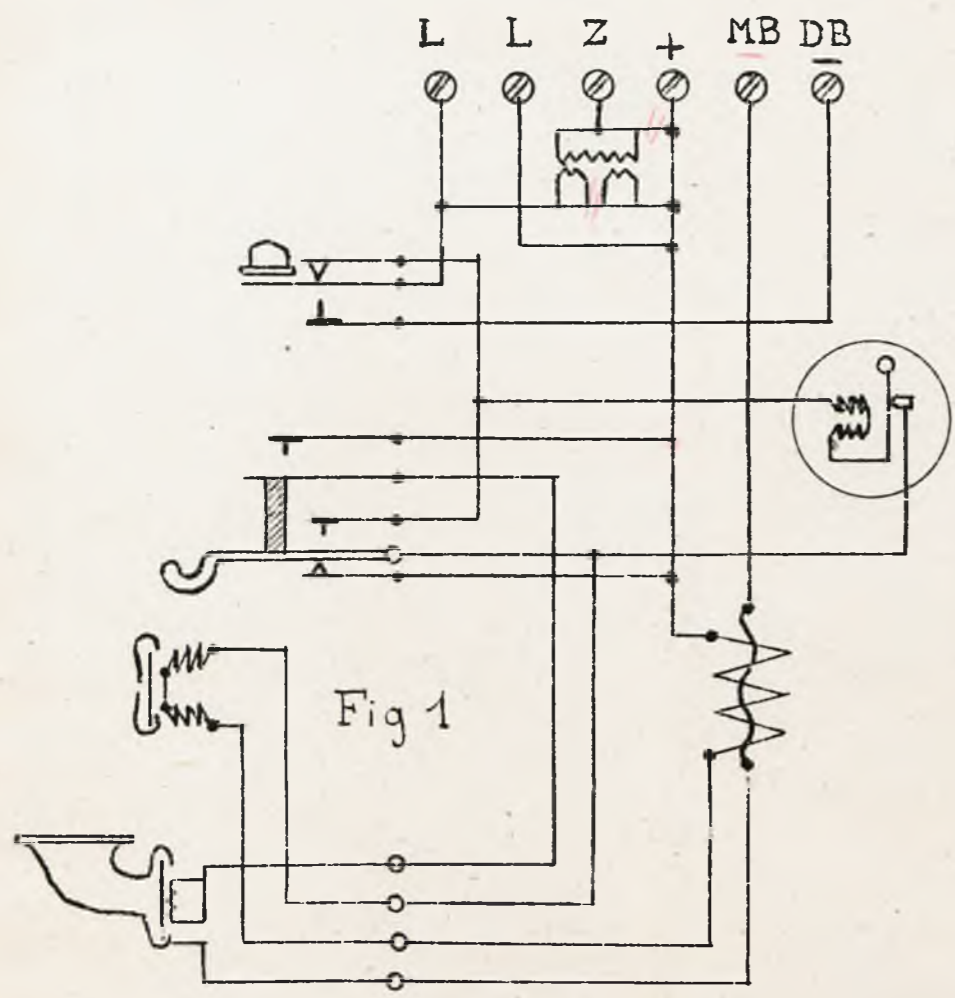

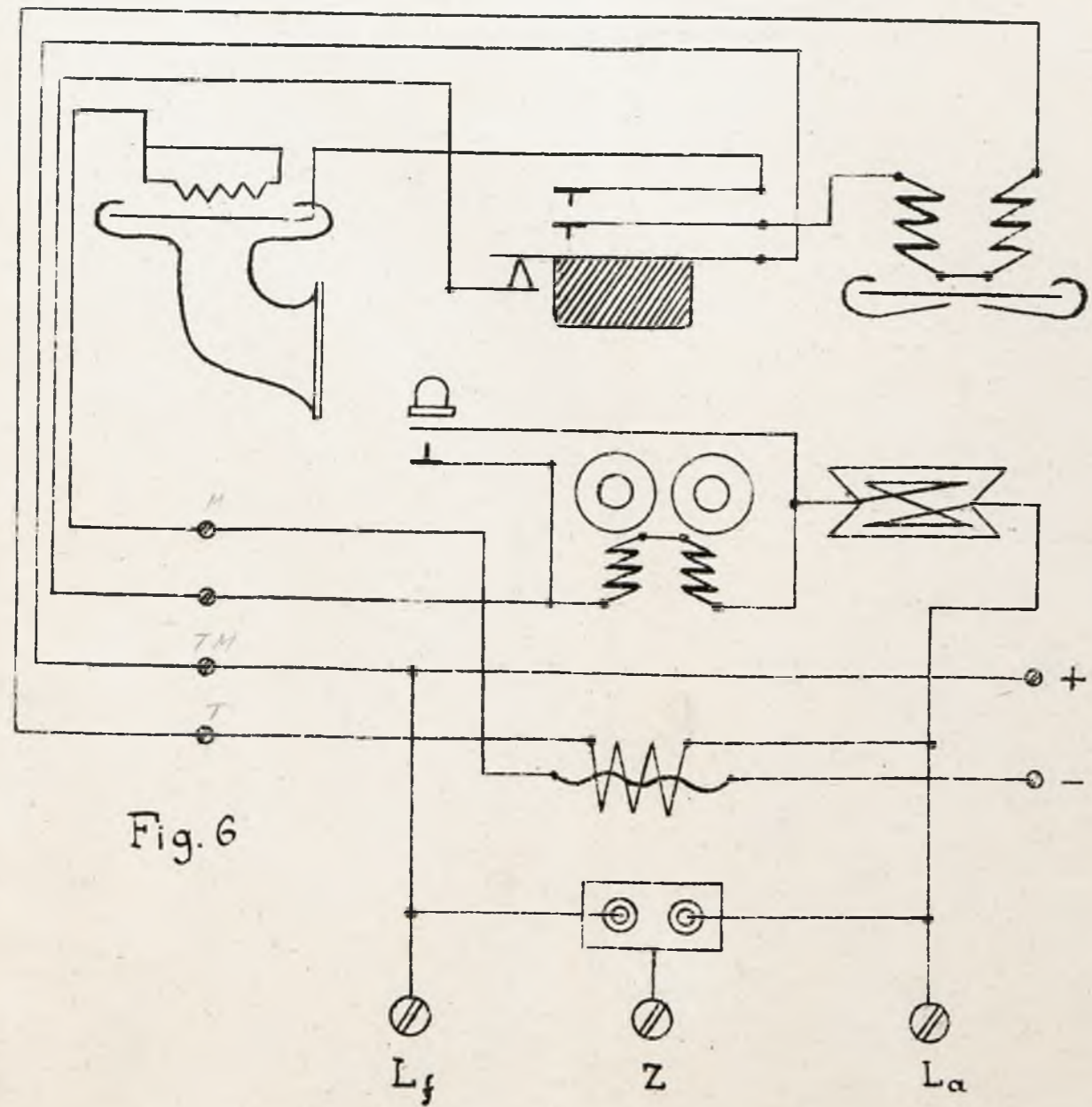

BIBLIOTEKA  
"KOŁA ELEKTRYKÓW"  
Stud. Politech. Warsz.

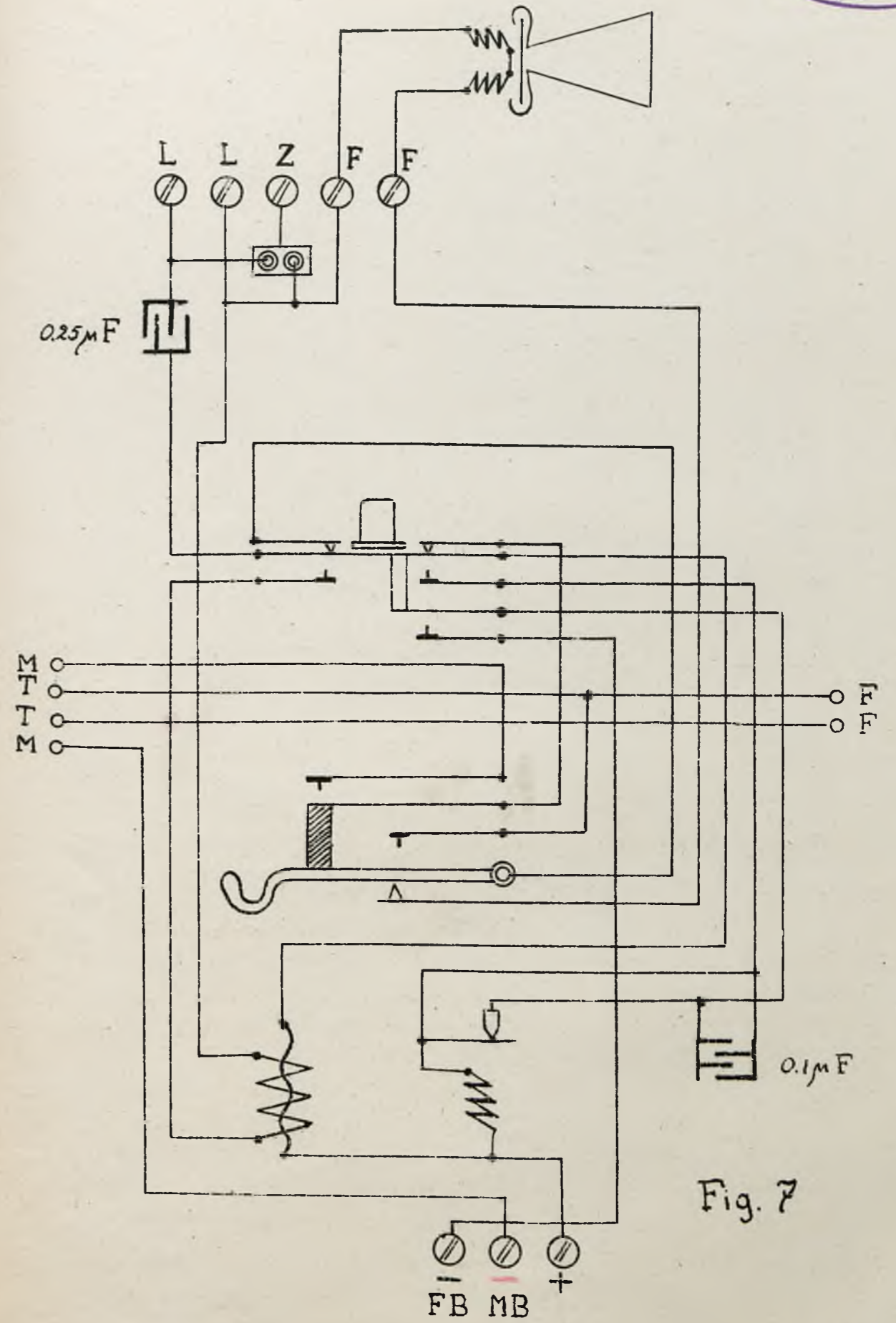
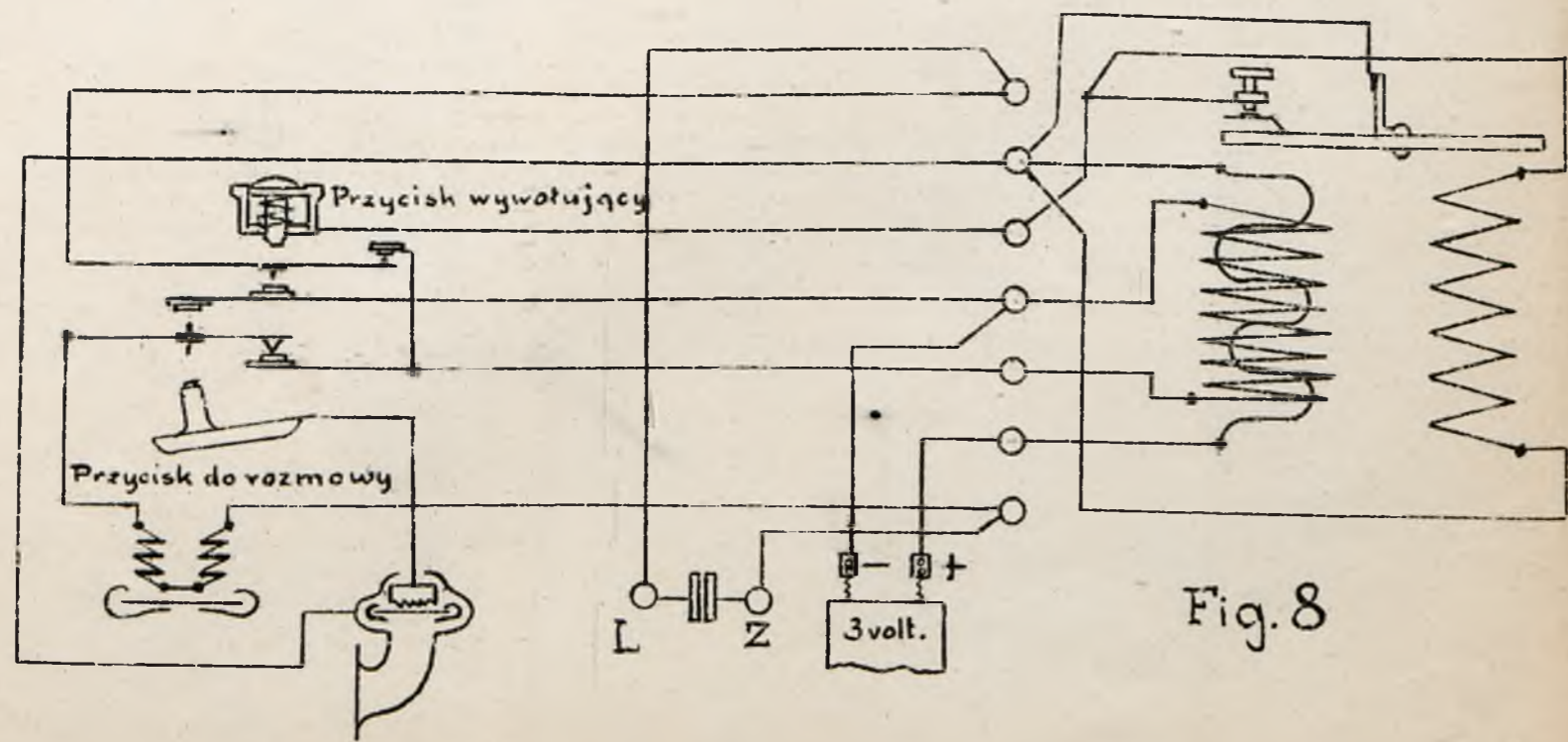

Fig. 10

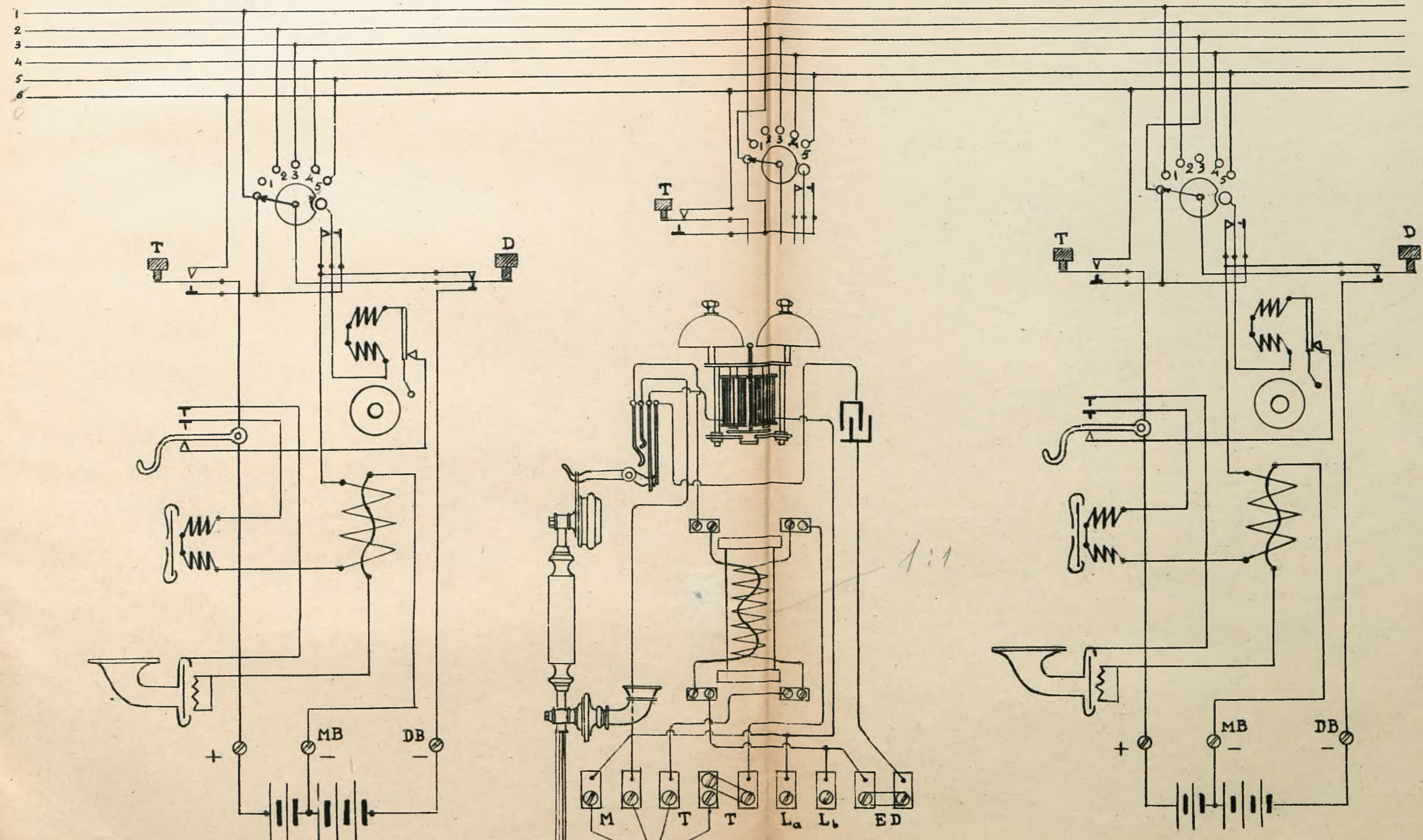
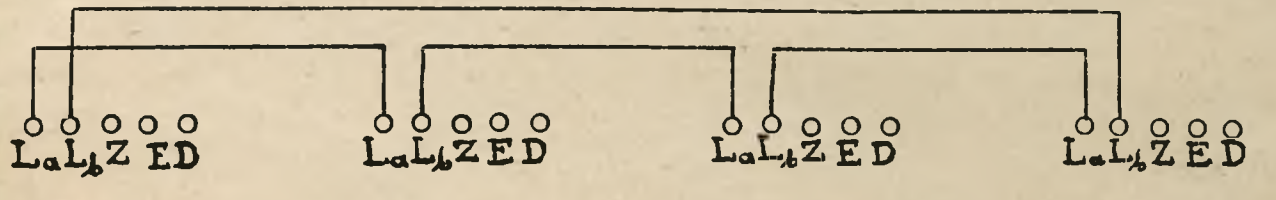
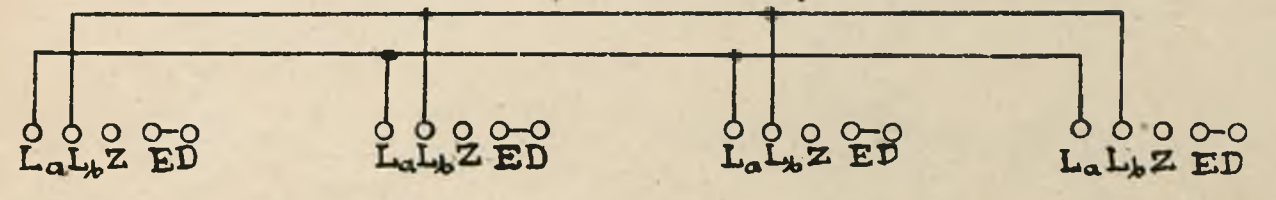
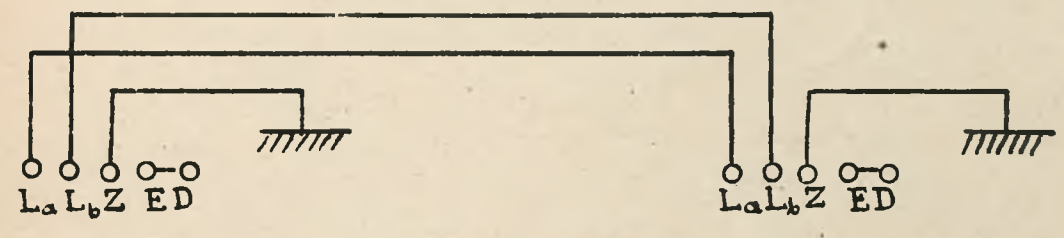
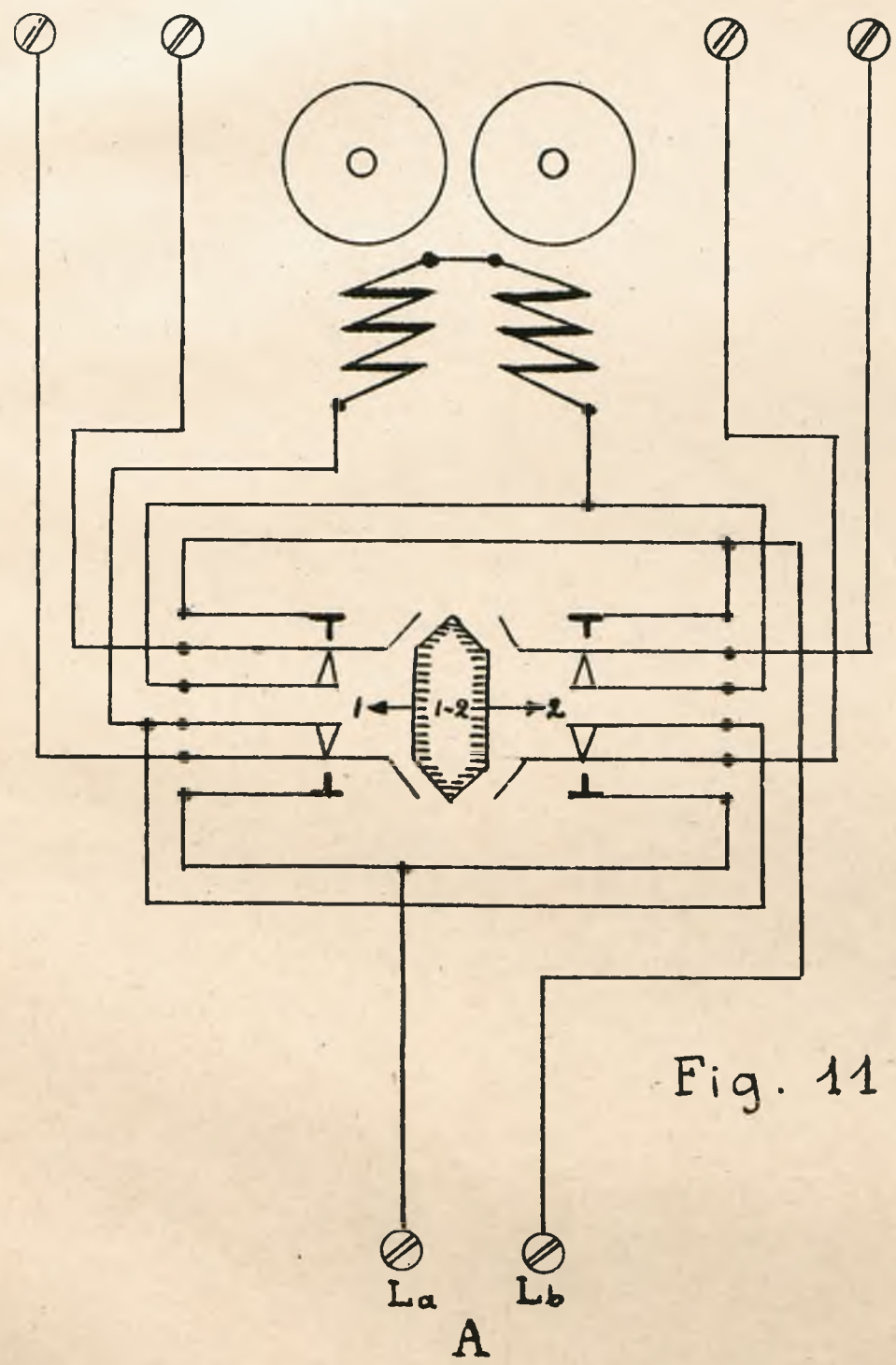

Fig. 9



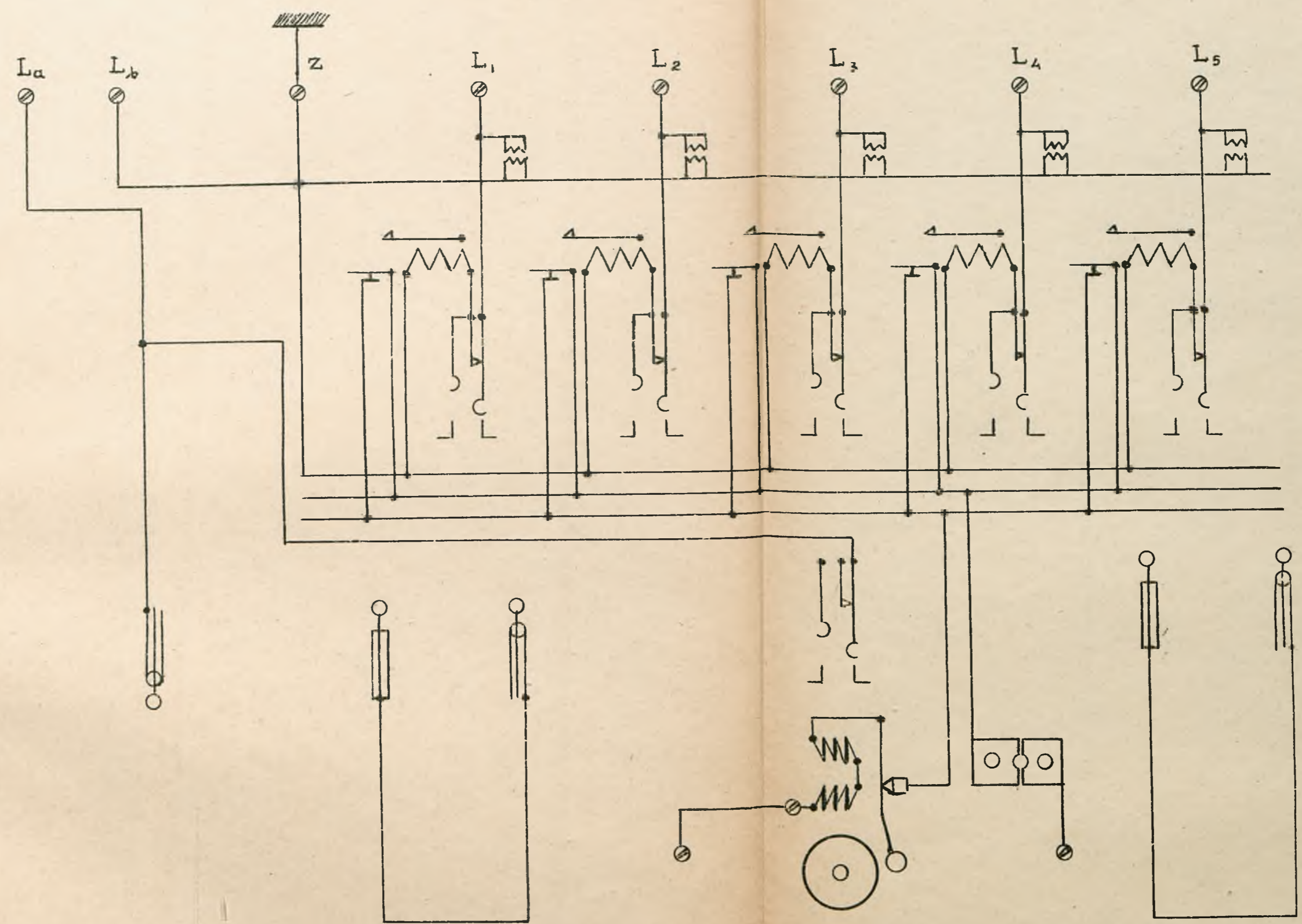

Fig. 15

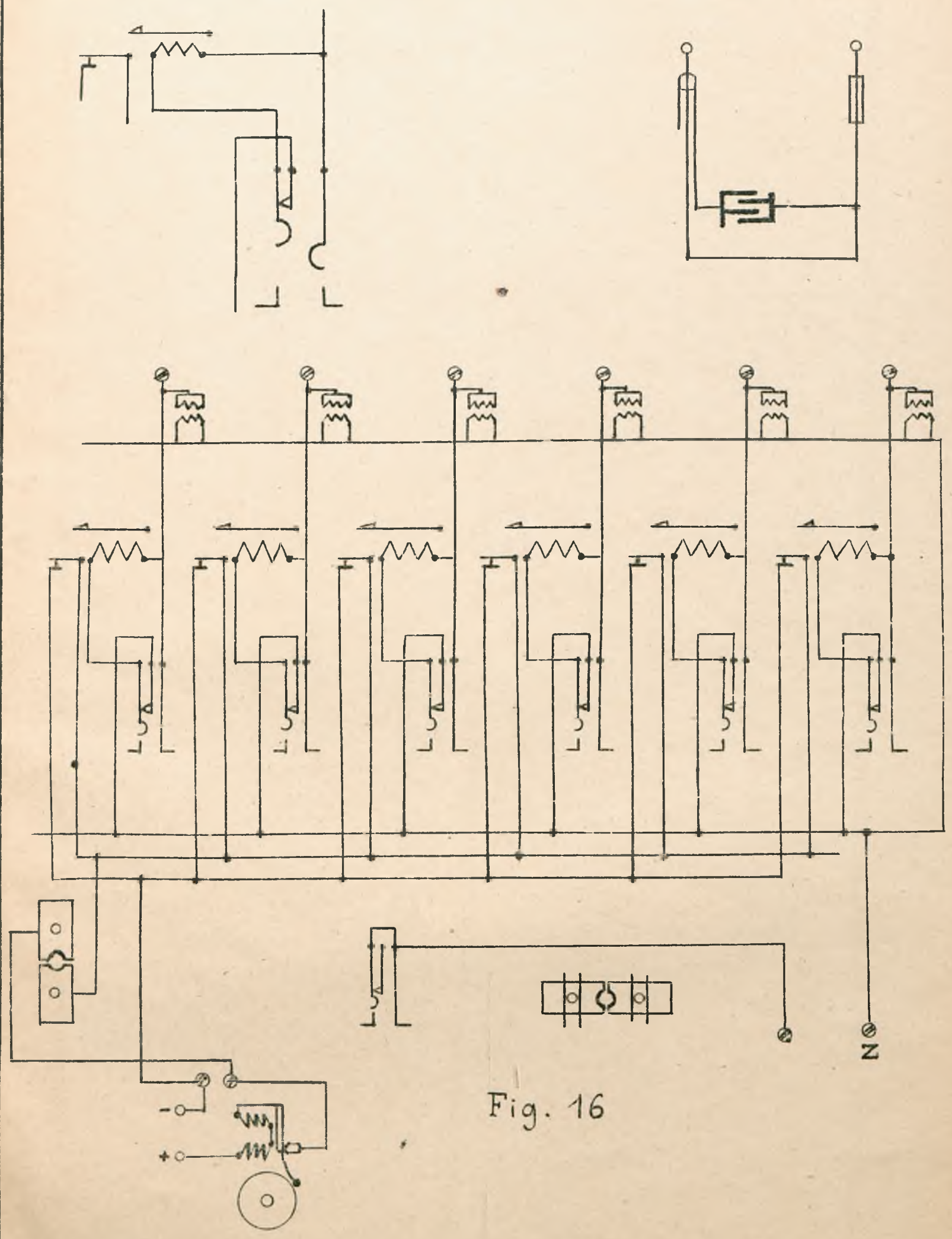

Fig. 16

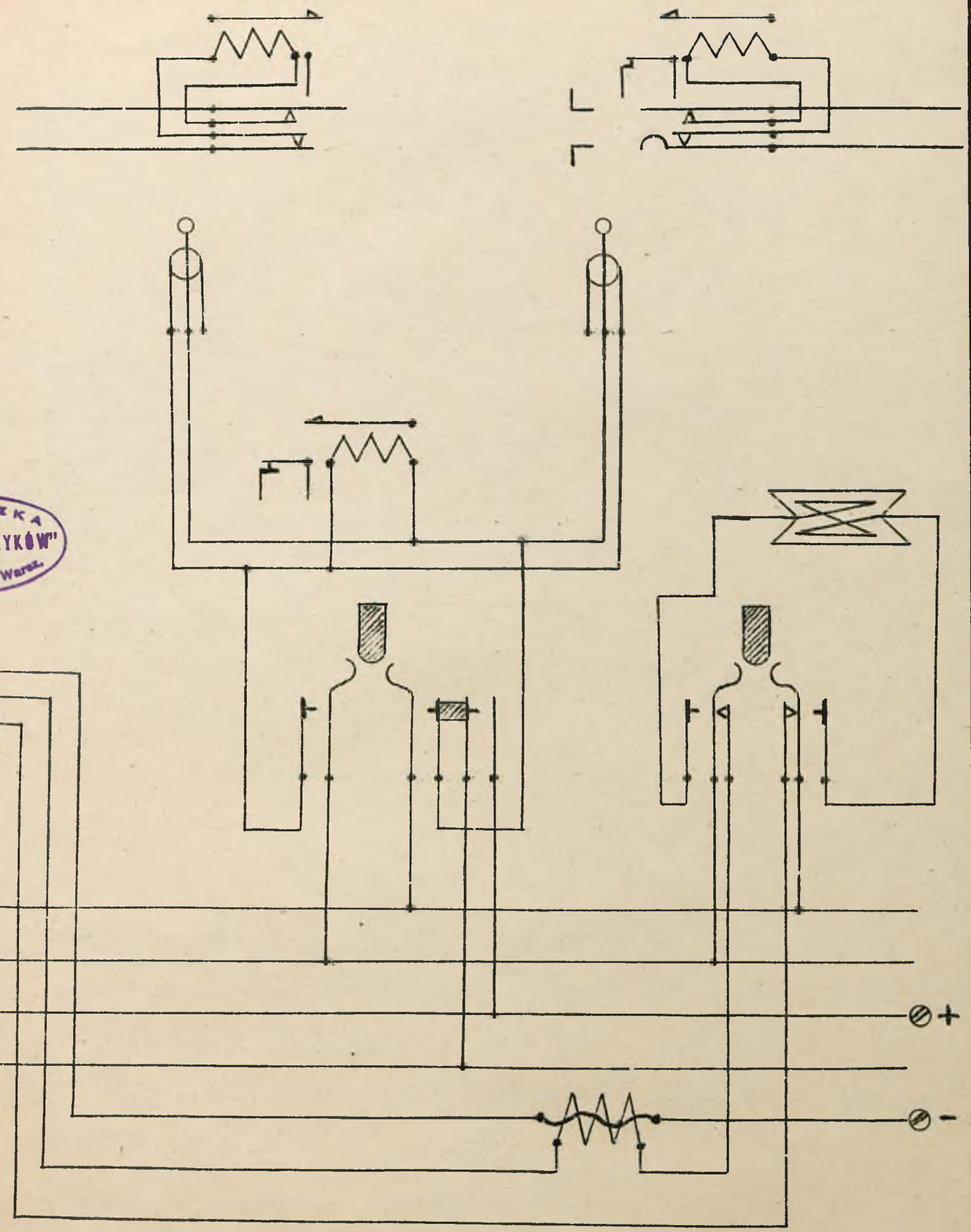
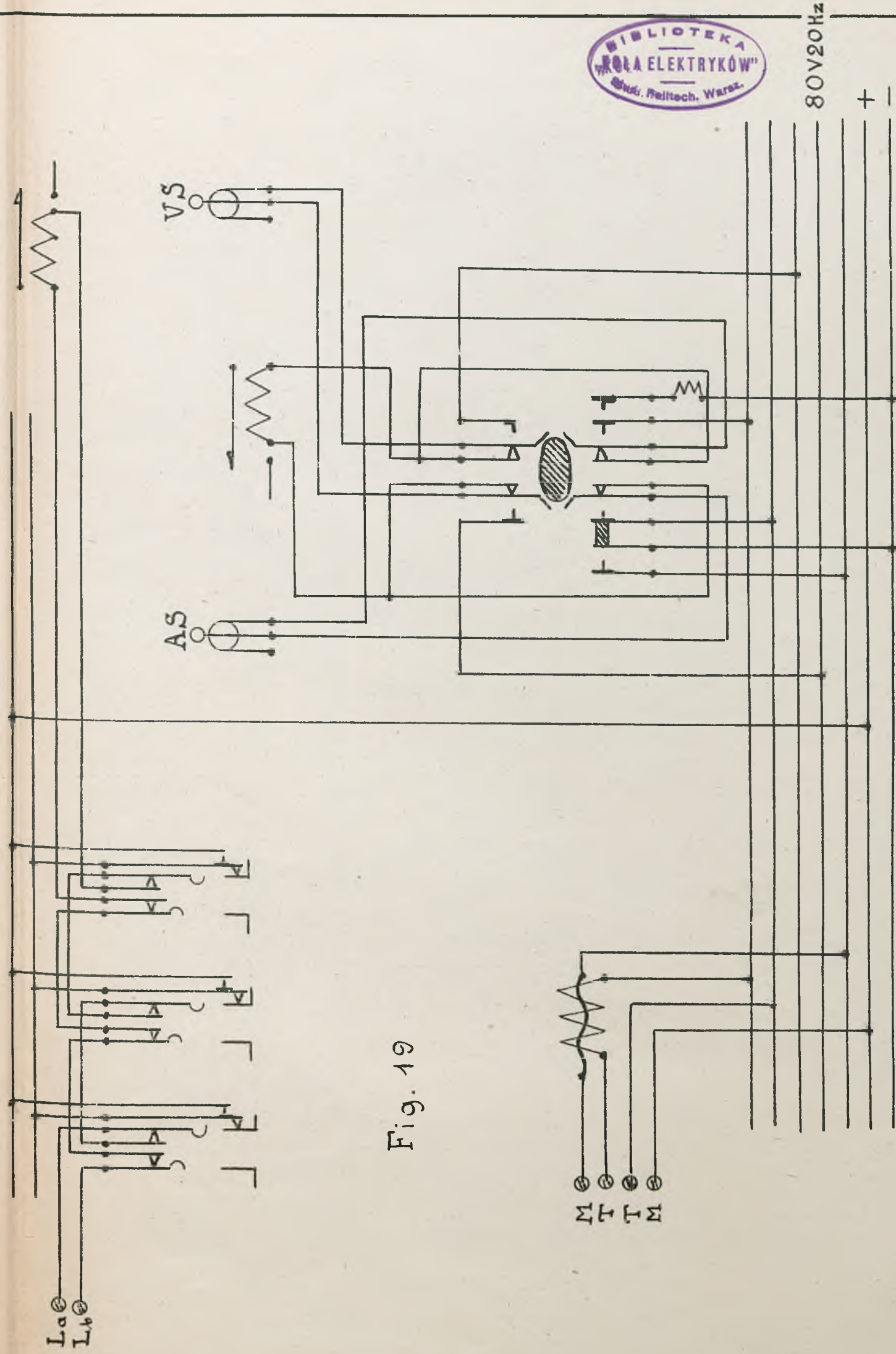
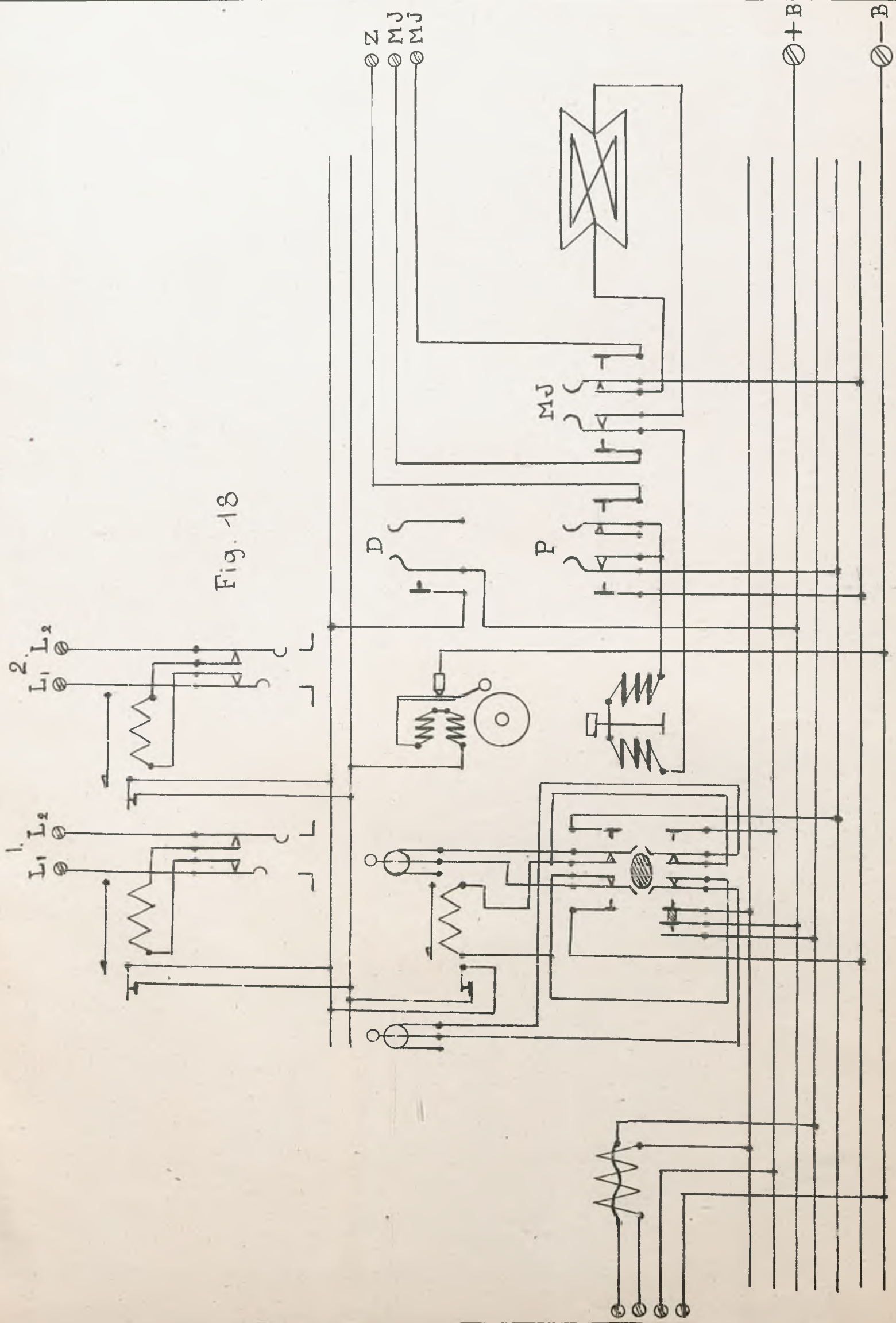

Fig. 17

BIBLIOTEKA  
 "KOŁA ELEKTRYKÓW"  
 Stud. Politech. Warsz.





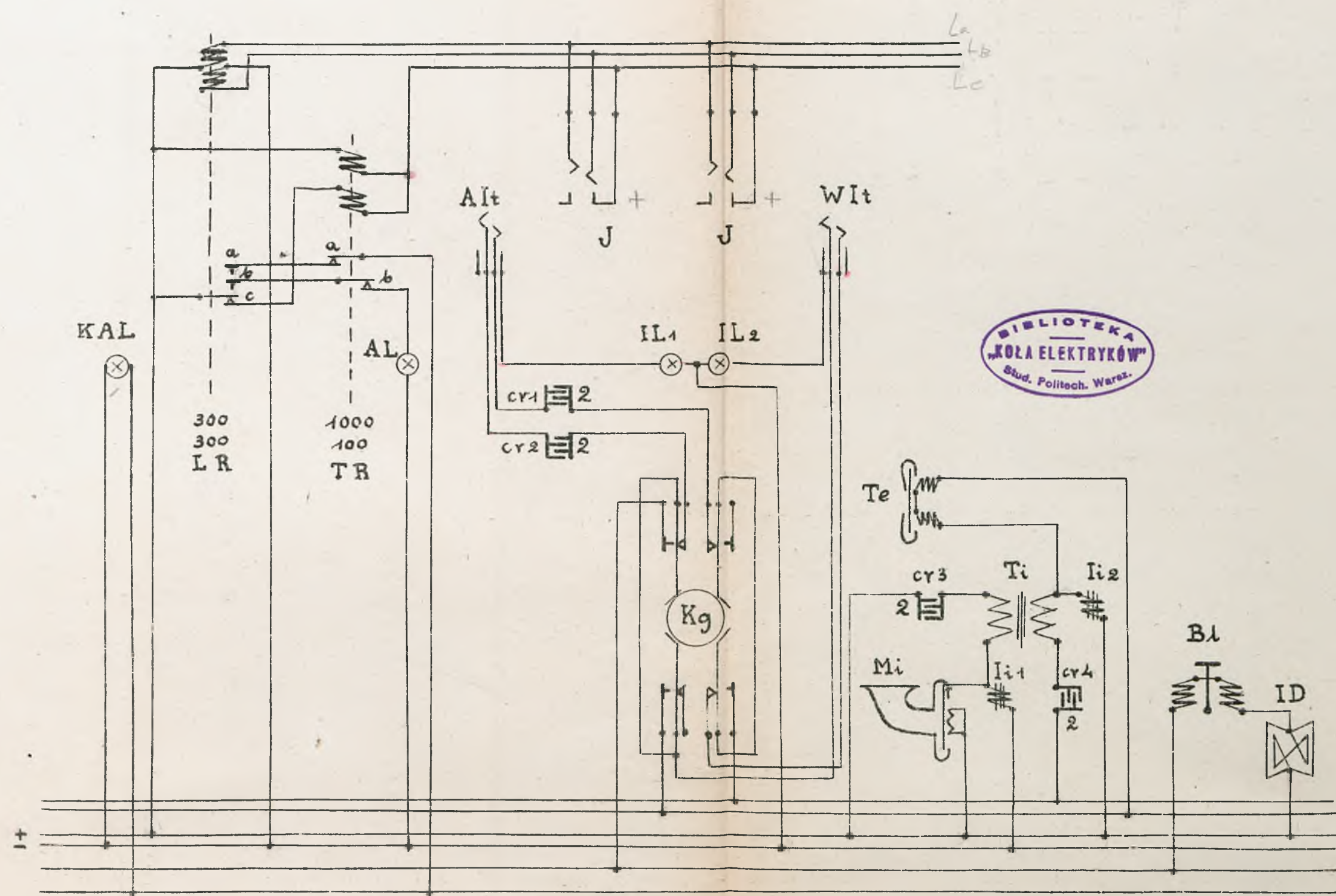

Fig. 20

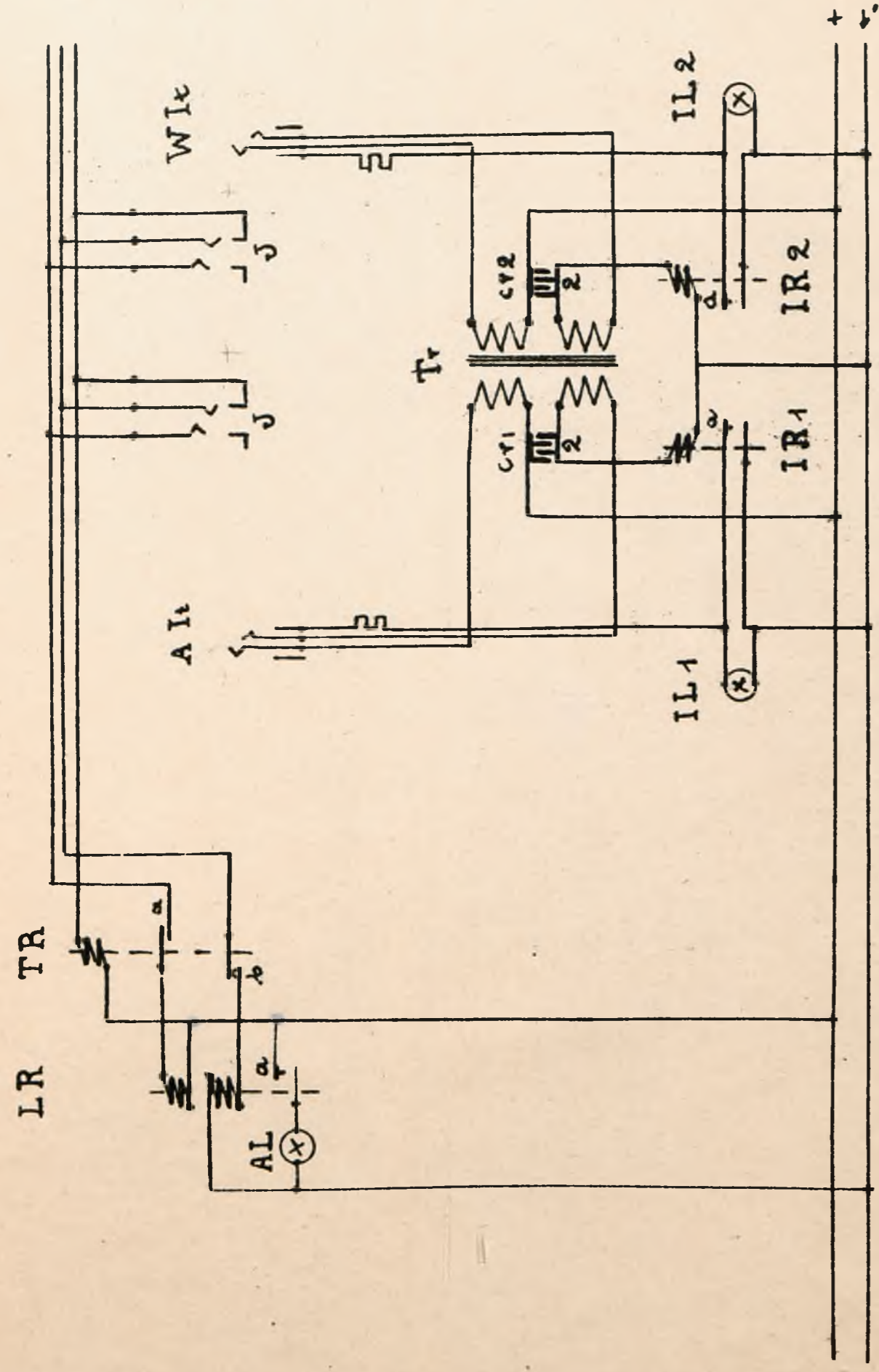

Fig. 21

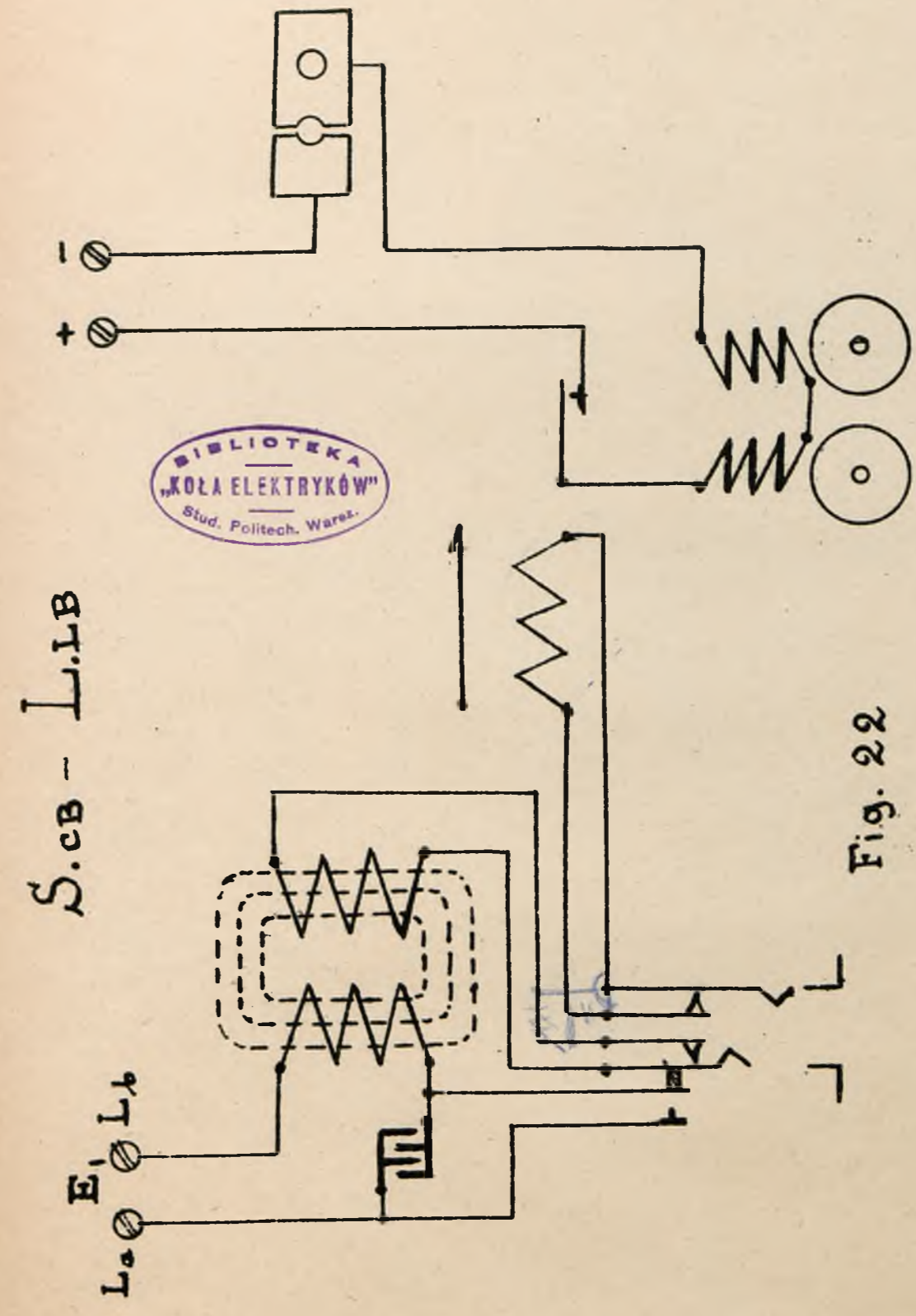
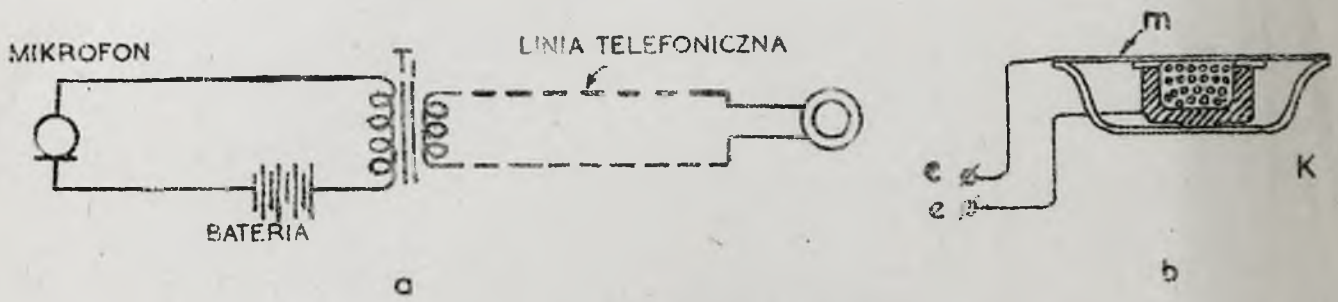
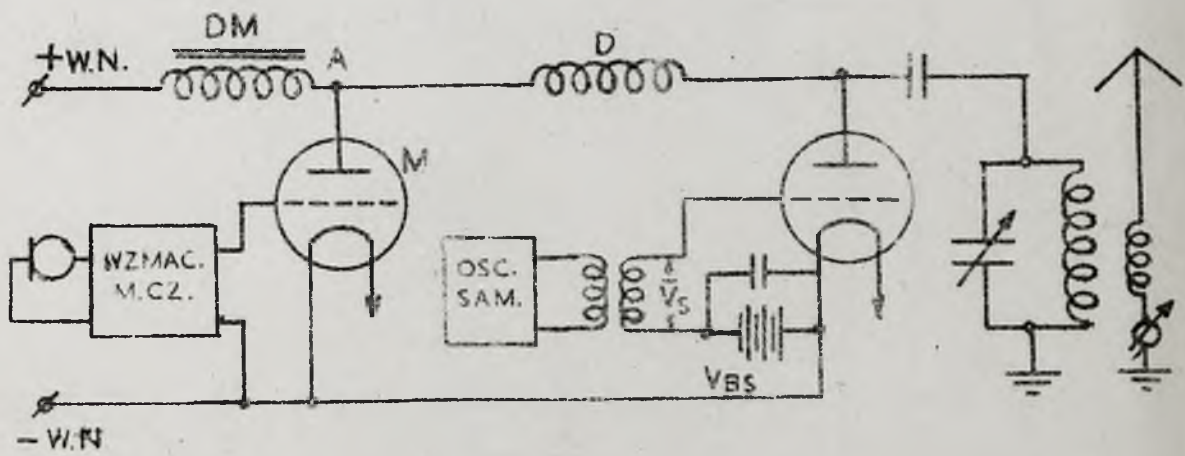

Fig. 22



Rys. 234.



Rys. 235.

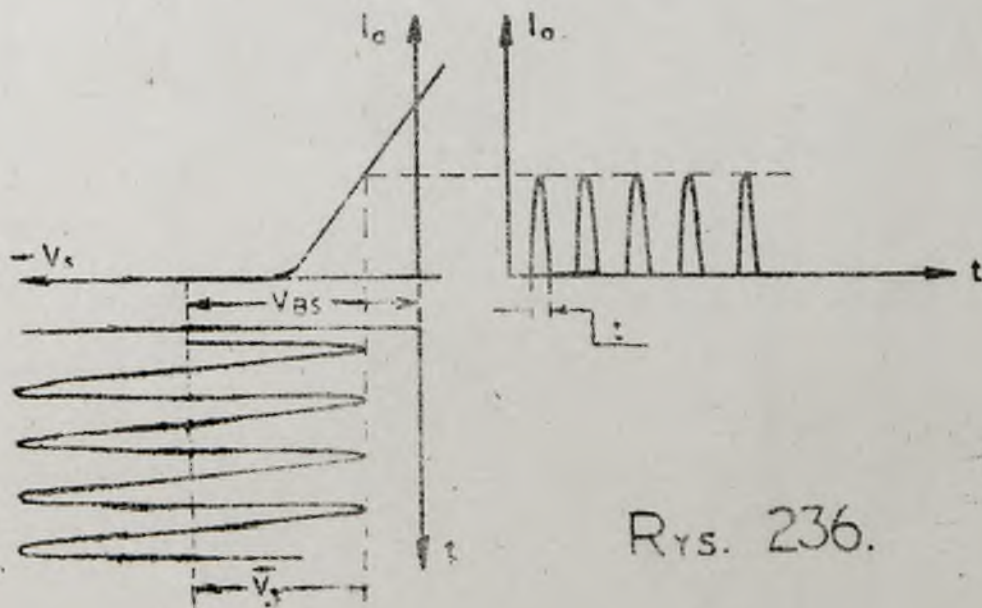

Rys. 236.