

OPRAWIONO
w
Komisji Wydawniczej
Instytutu Pom. Stud. Pol. Warsz.

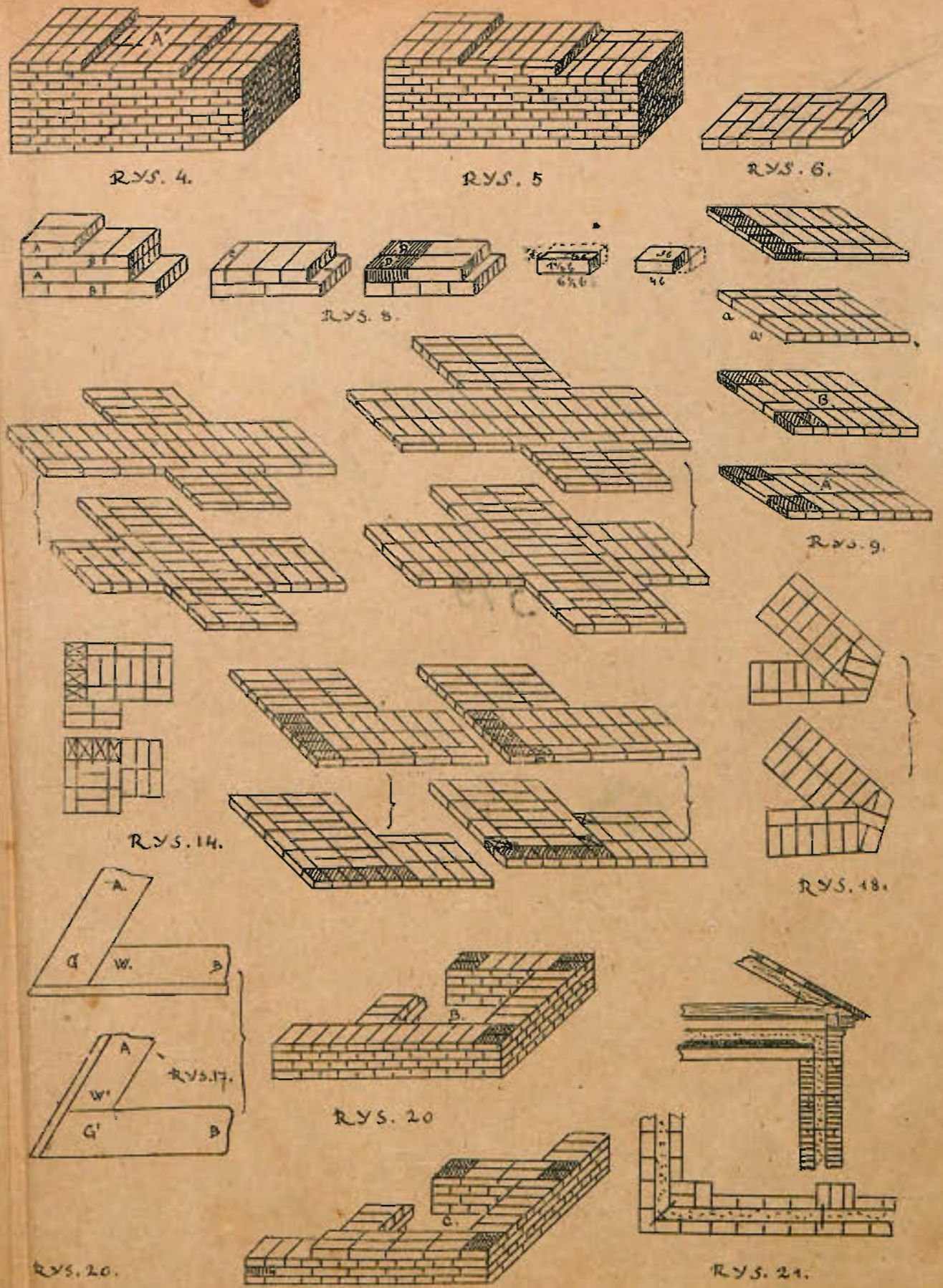

Atlas

do budownictwa ogólnego
prof. dr. Fedorowicza

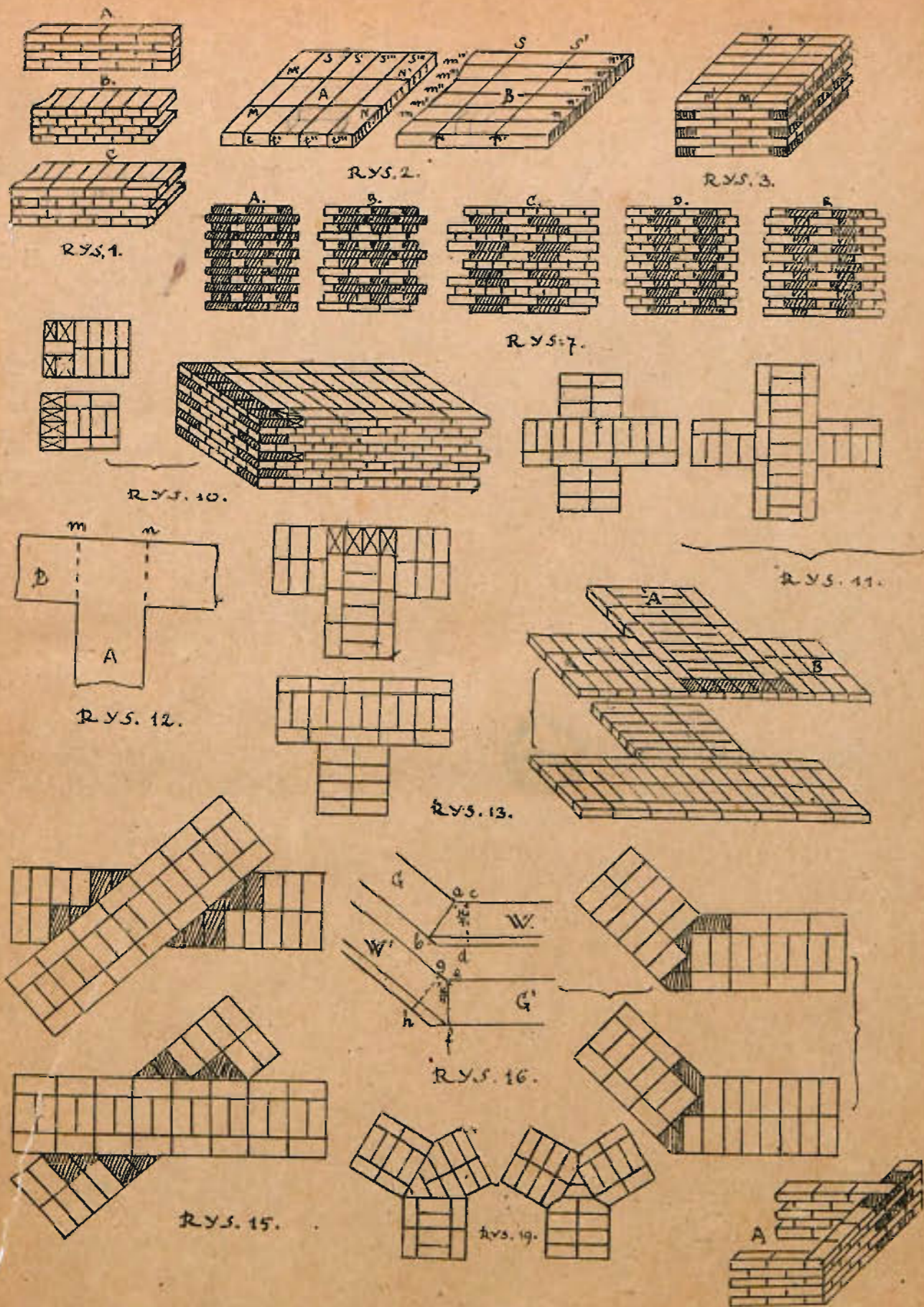



RYS. 22.

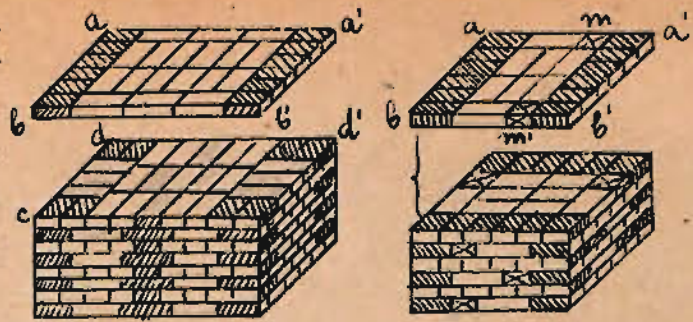

RYS. 23

RYS. 24

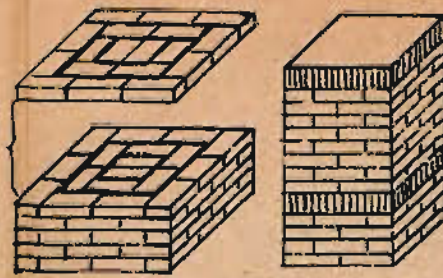

RYS. 25

RYS. 26

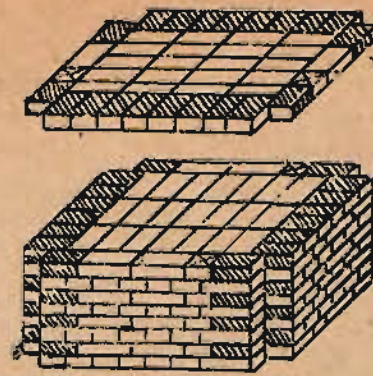

RYS. 27.

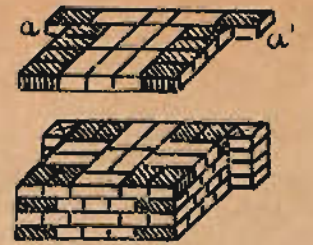

RYS. 28.

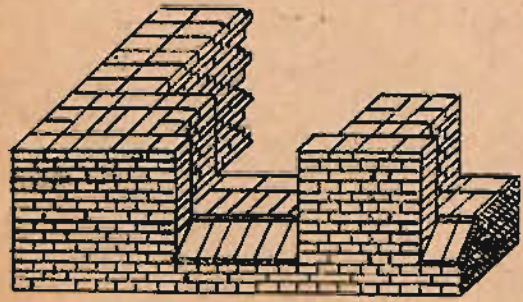

RYS. 29.

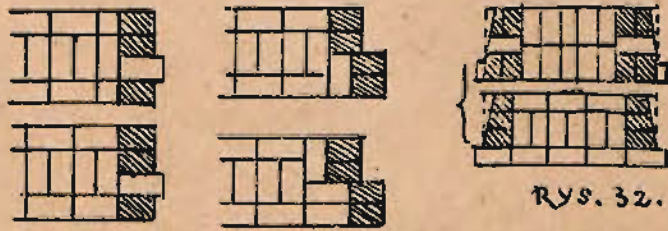

RYS. 30

RYS. 31.

RYS. 32.

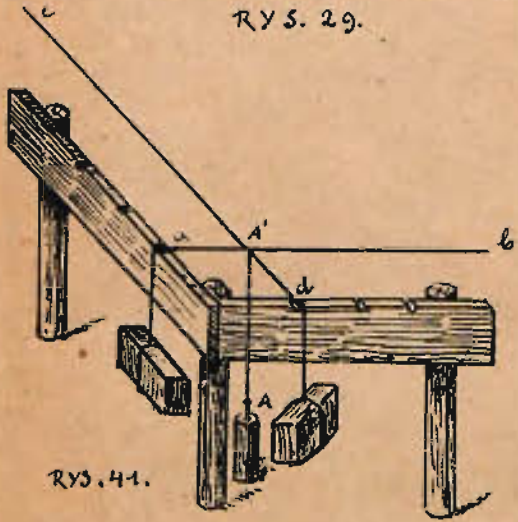

RYS. 41.

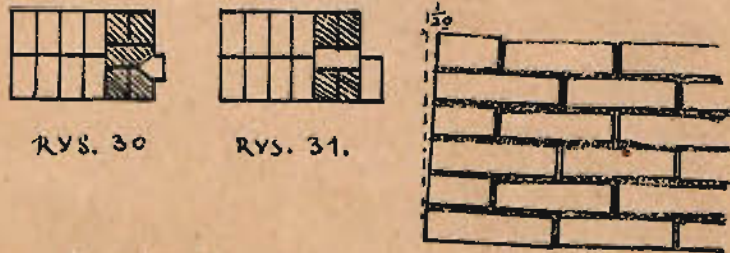

RYS. 33.



RYS. 38

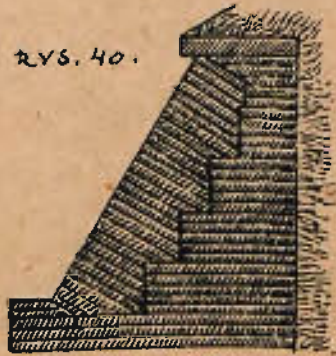

RYS. 40.

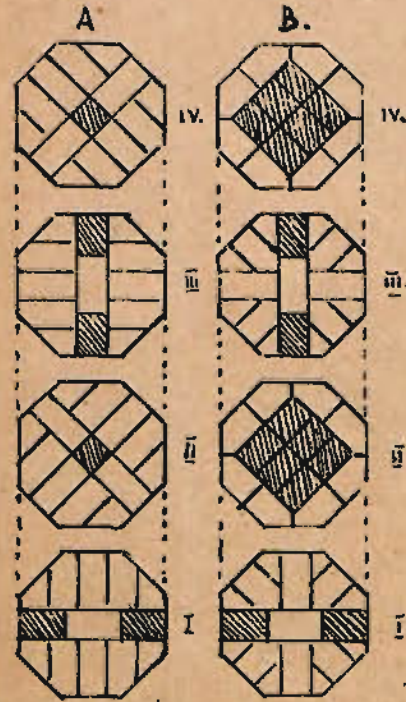

RYS. 35.

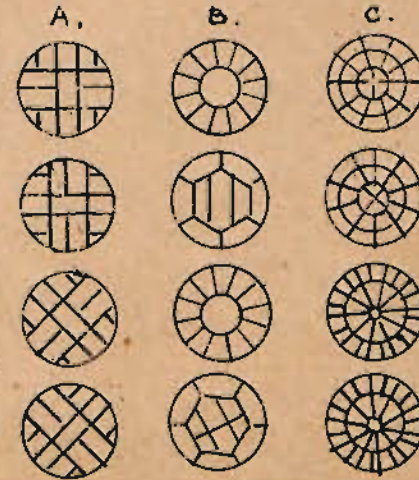

RYS. 34.

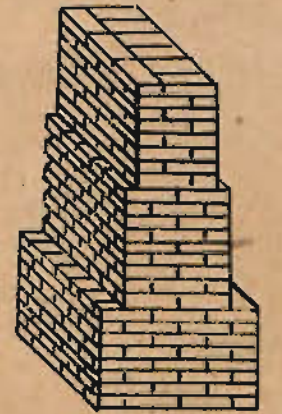

RYS. 37.

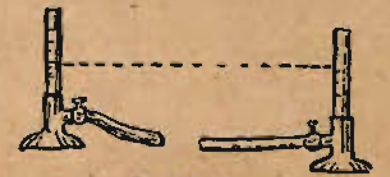

RYS. 42.

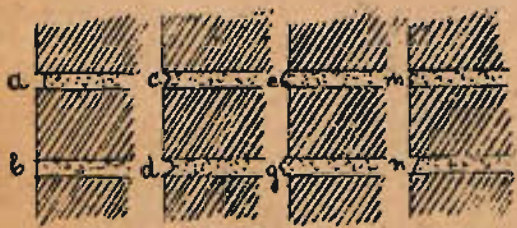

RYS. 43

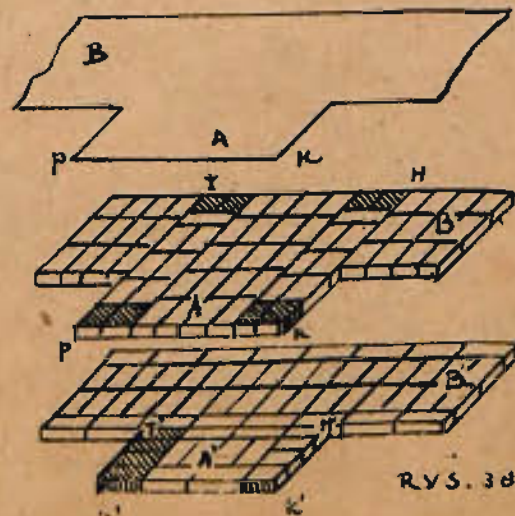

RYS. 38.

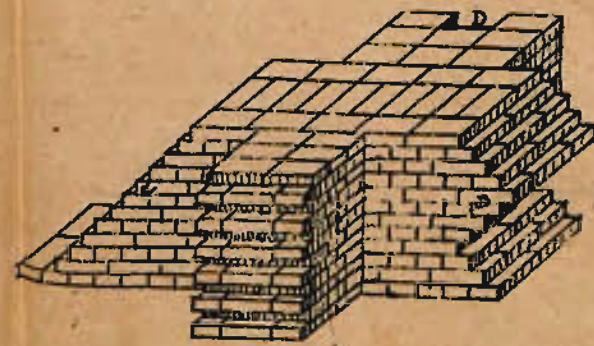

RYS. 44.



RYS. 35.

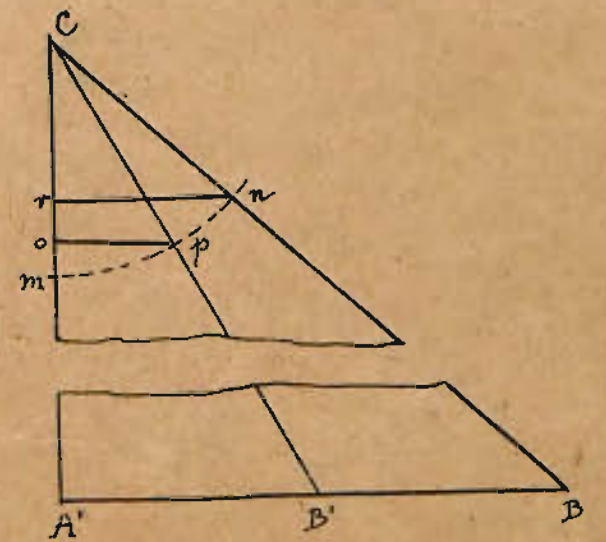

RYS. 45.

BVDOWNICTWO OGOLNE TABLICA II.

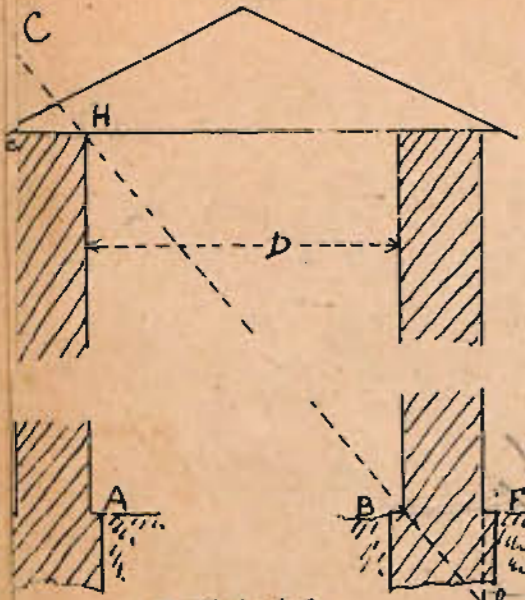

RYS. 46.

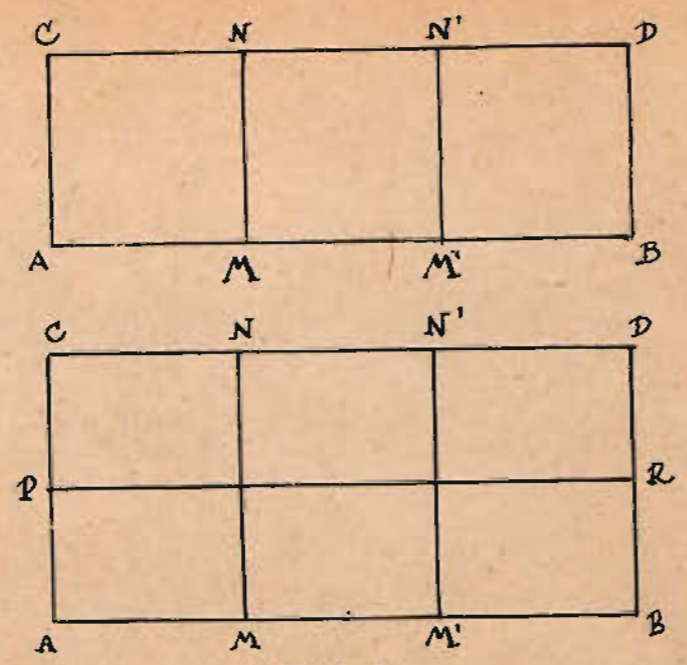

RYS. 47.

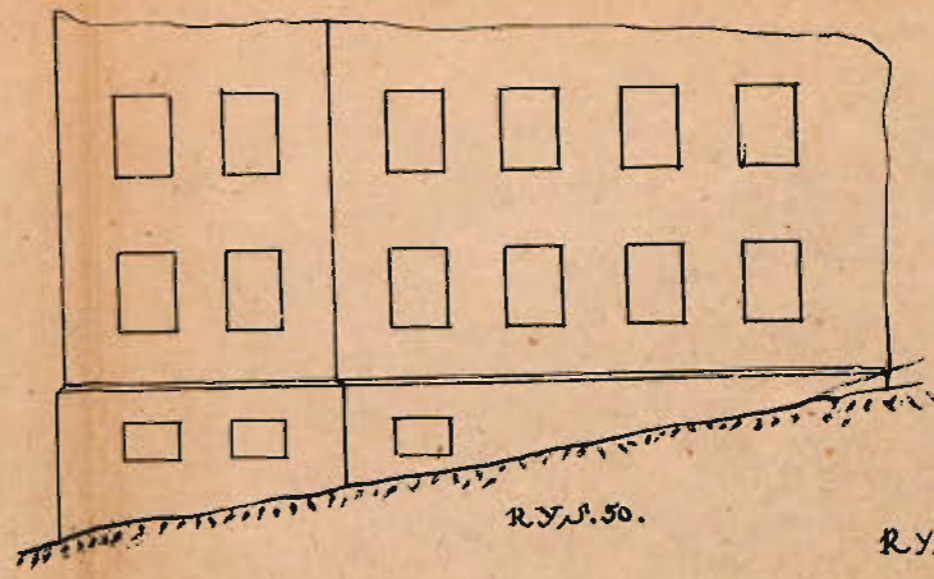

RYS. 50.

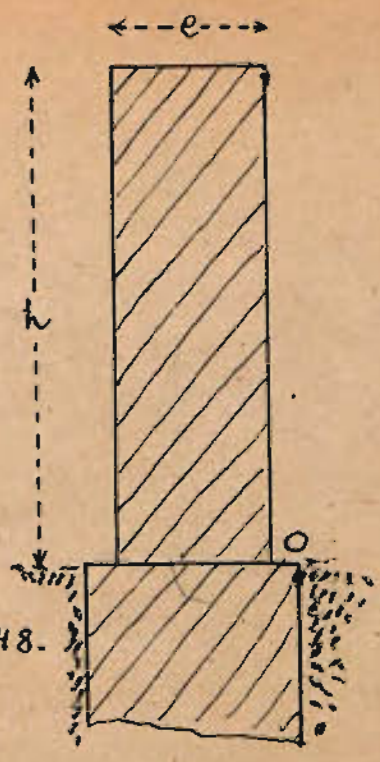

RYS. 48.

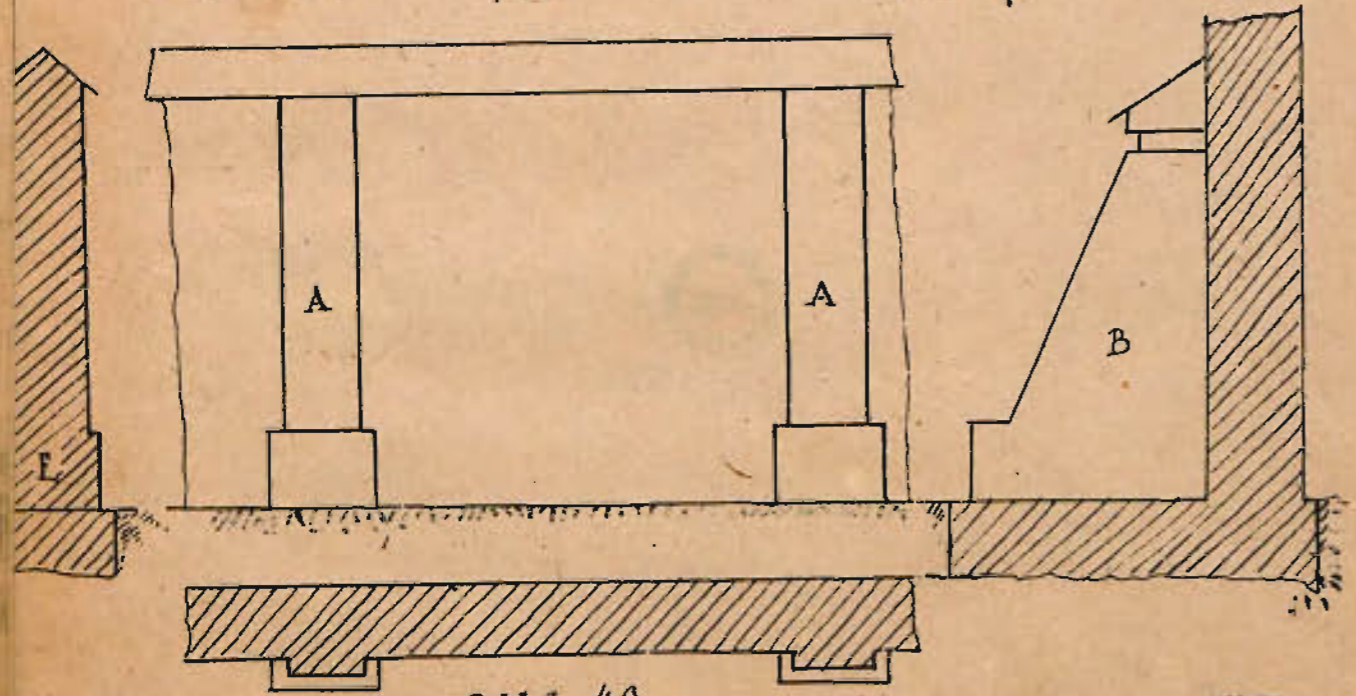

RYS. 49.

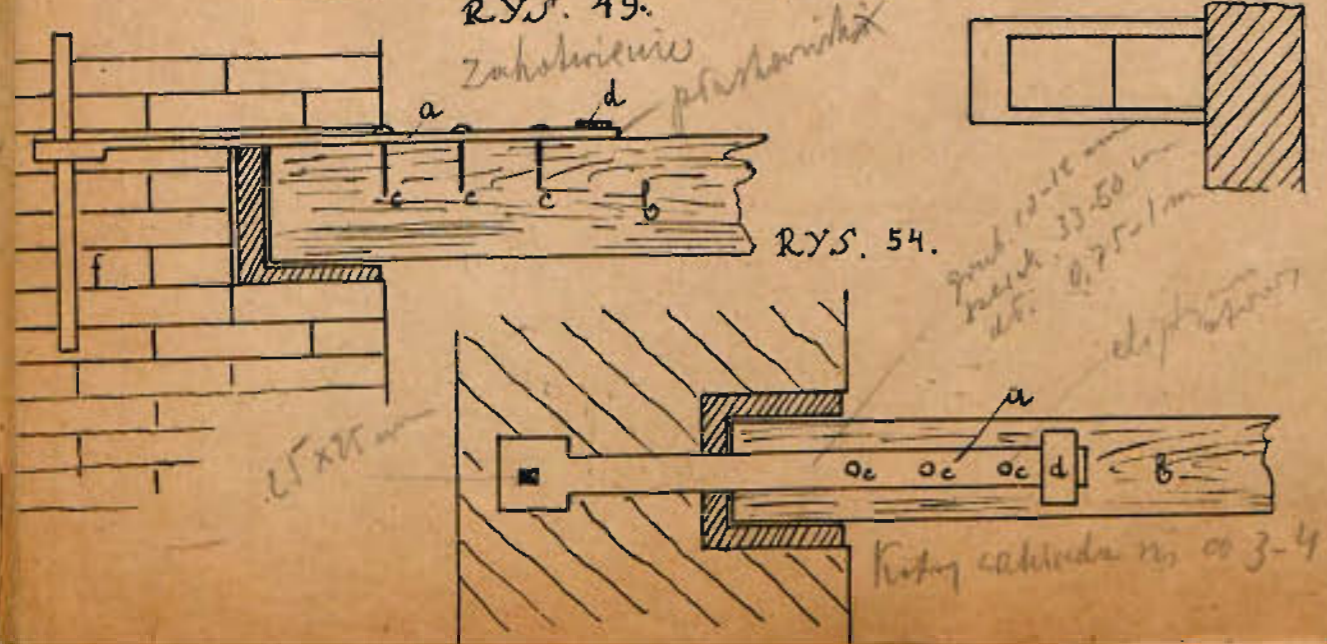

RYS. 54.

*Przed 12-15 m
miejsc 33-50 m
dł. 0,75-1 m
dł. 0,75-1 m*

Kraty stalowe nr. 00 3-4 klatki

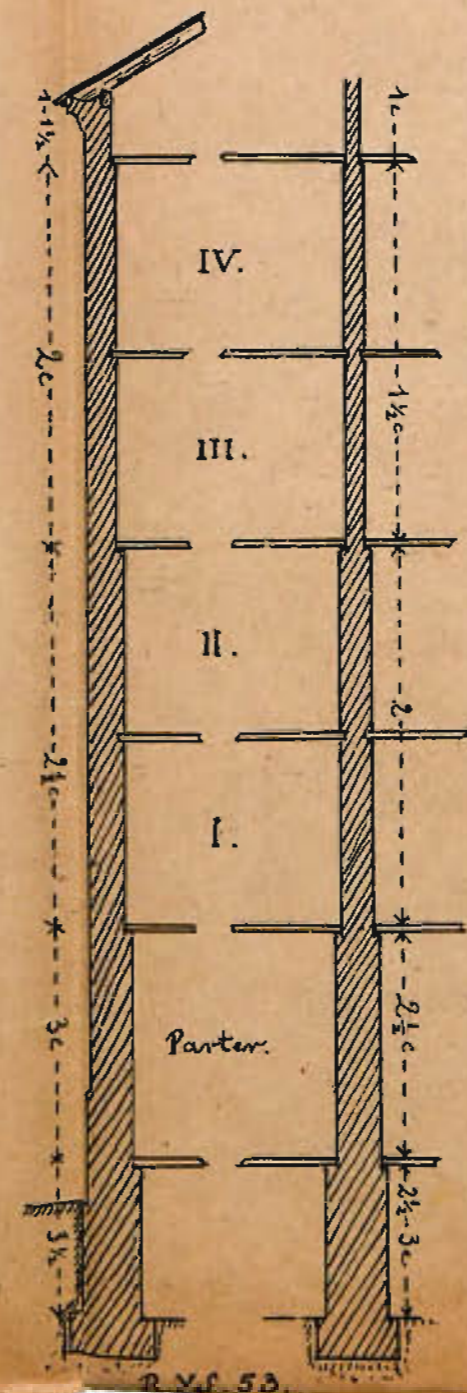

RYS. 53.

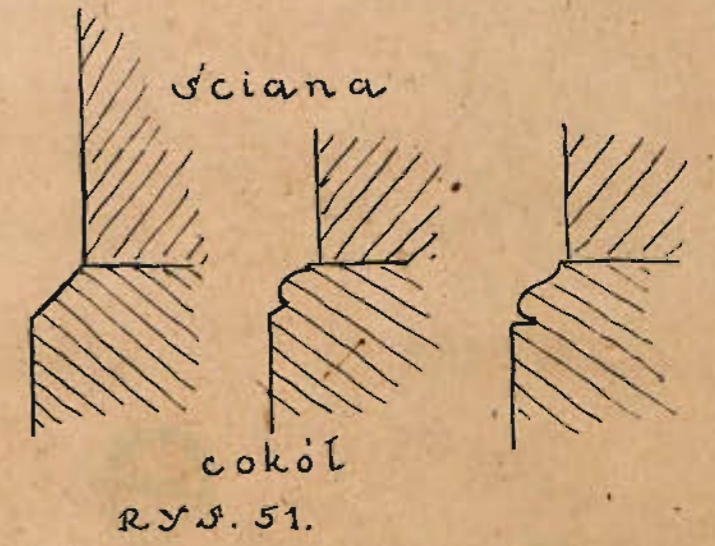

RYS. 51.

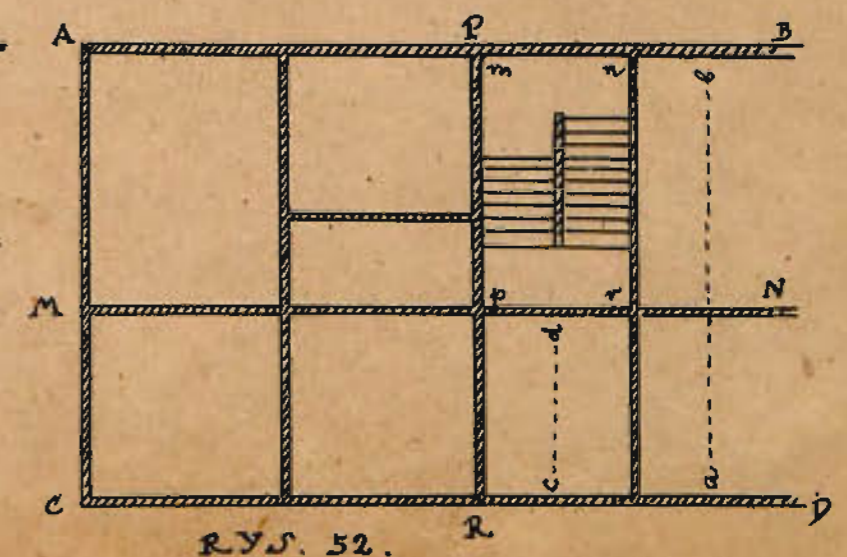

RYS. 52.

BUDOWNICTWO OGÓLNE TABLICAMI.

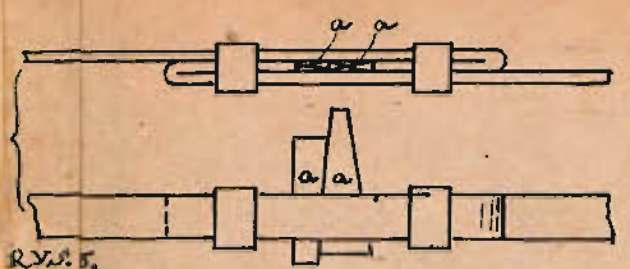

RYS. 55.

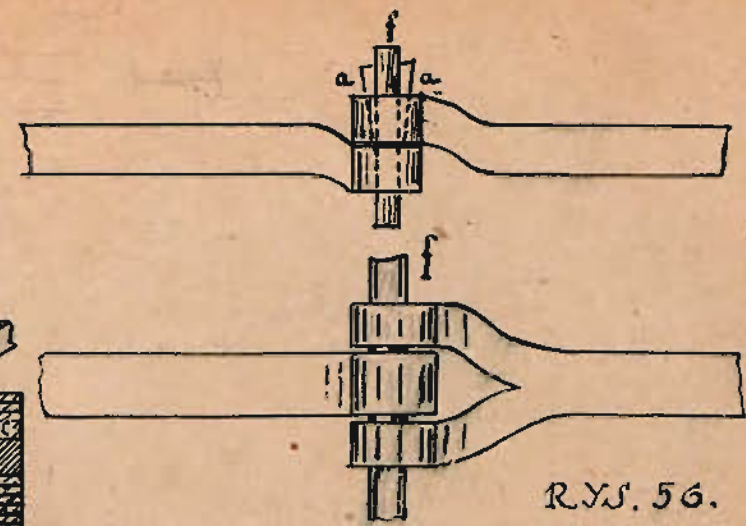

RYS. 56.

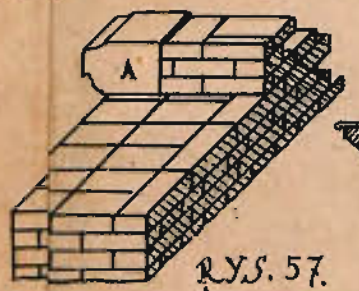

RYS. 57.



RYS. 59.

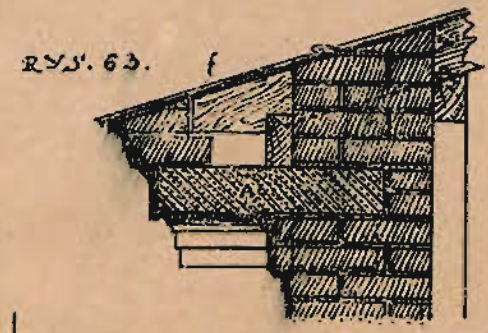

RYS. 63.

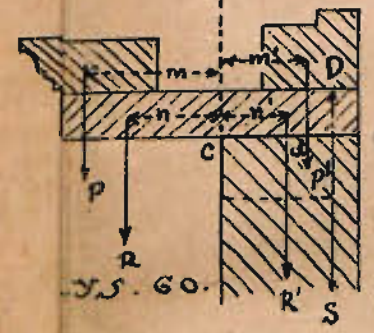

RYS. 60.



RYS. 65.

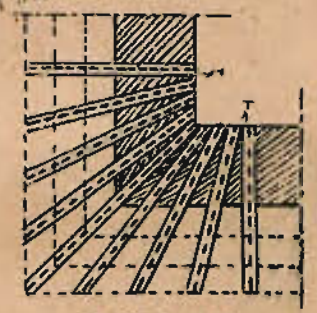

RYS. 66.

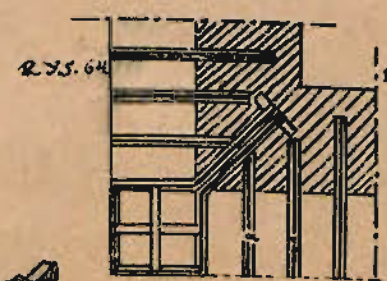

RYS. 64.

RYS. 67.

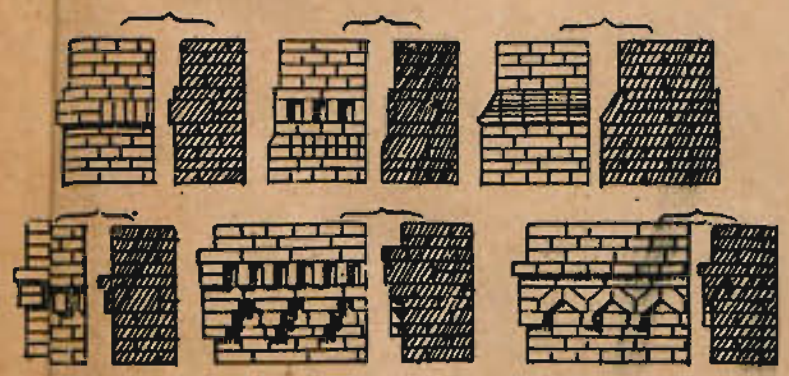

RYS. 61.



RYS. 62.

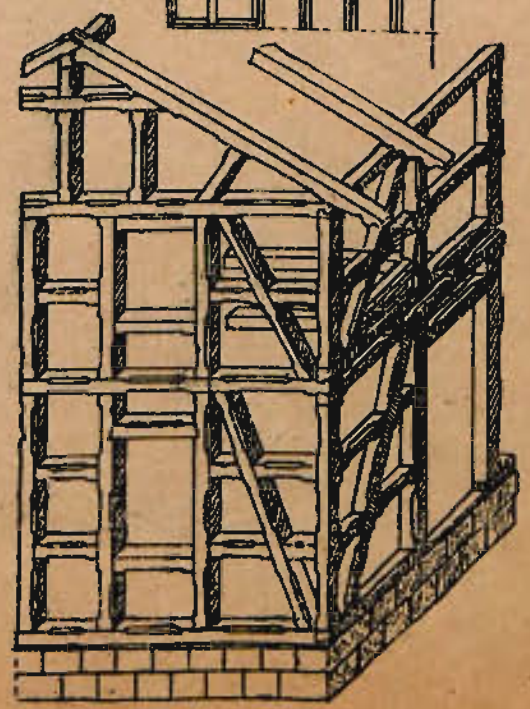

RYS. 68.

RYSVNKI od 55-57 i od 59-69.

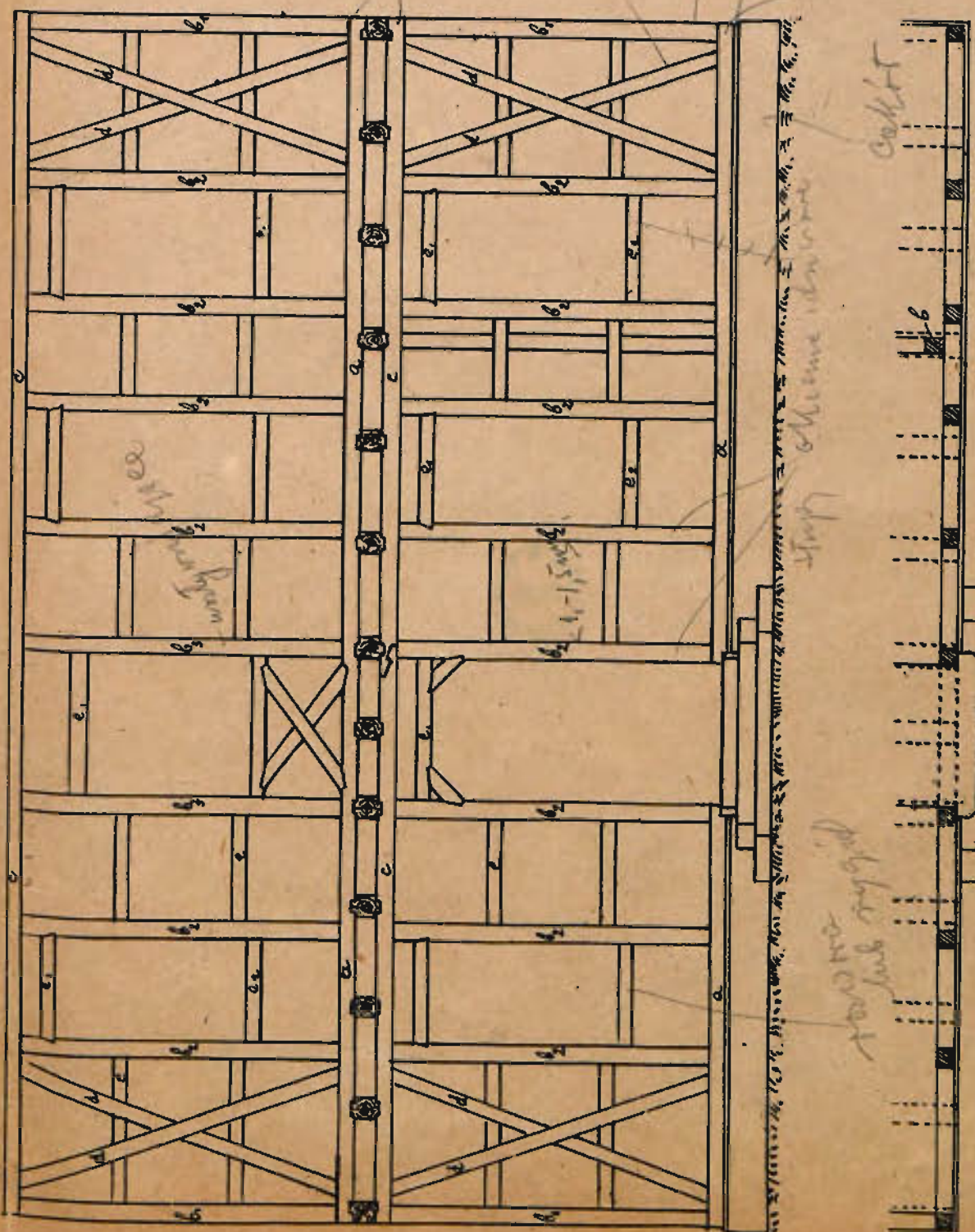

RYS. 69.

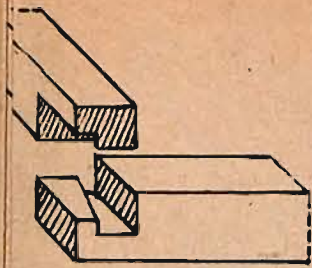

RYS. 70.

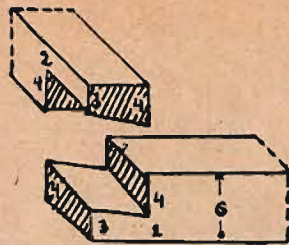

RYS. 71.

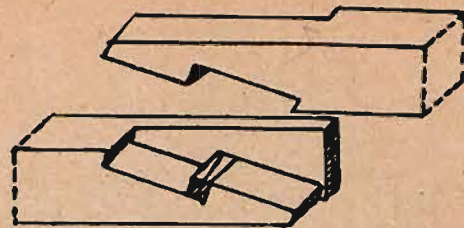

RYS. 72.

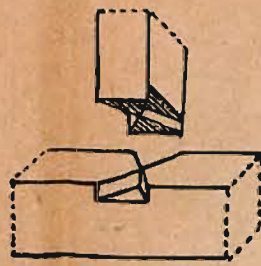

RYS. 74.

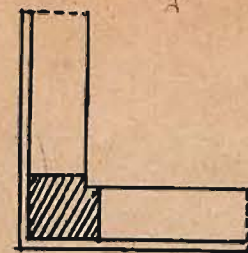

RYS. 76.

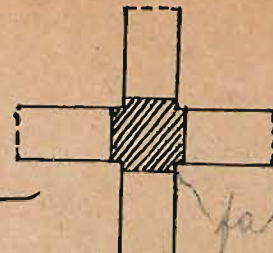

RYS. 79.

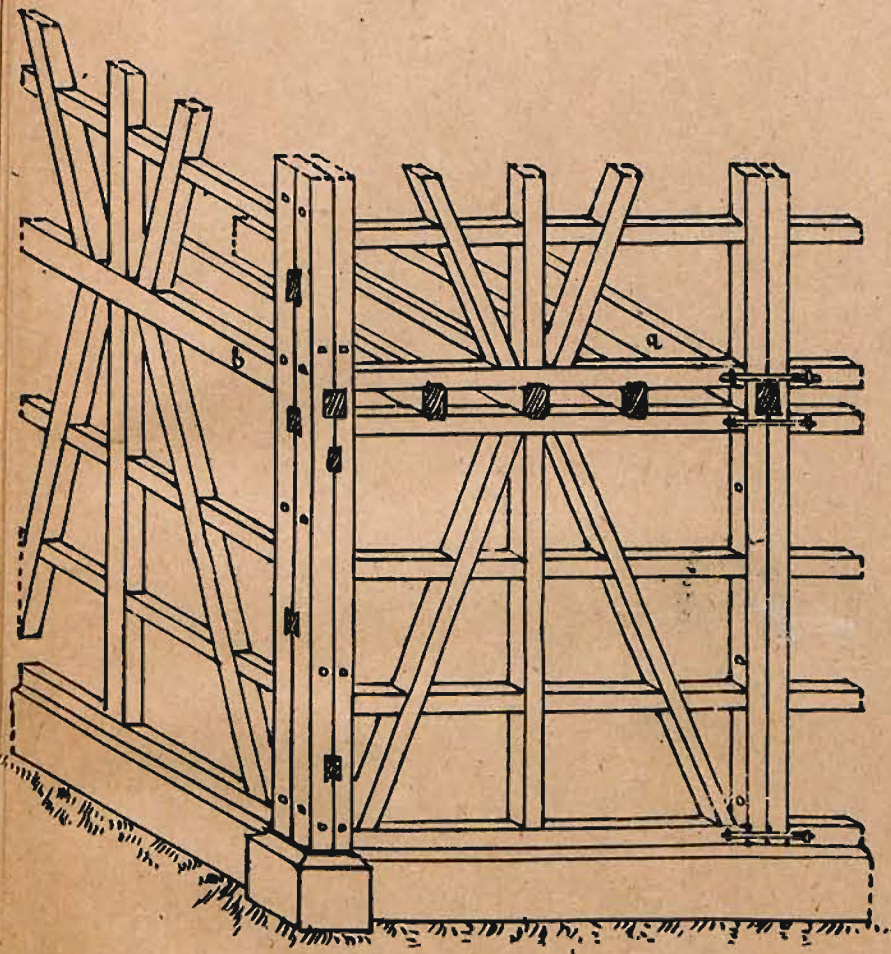

RYS. 78.

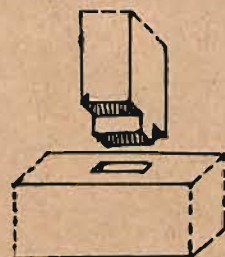

RYS. 73.



RYS. 75.

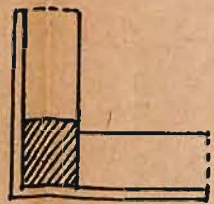

RYS. 77.

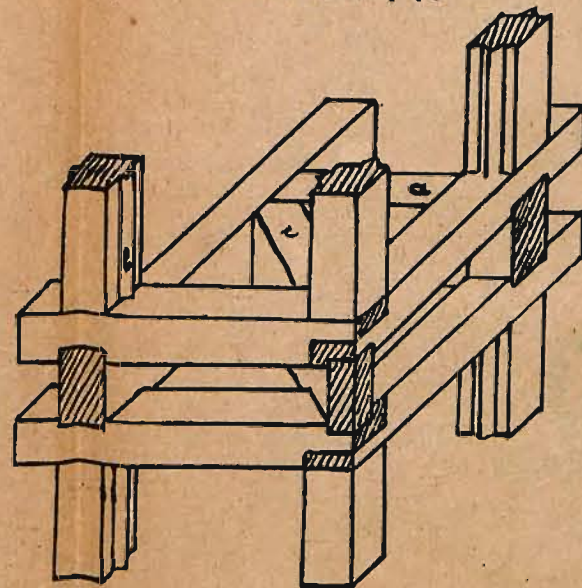
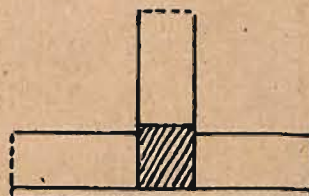

RYS. 84.

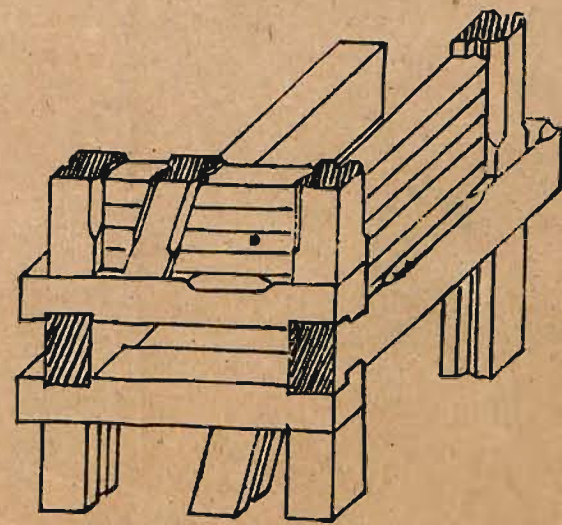

RYS. 83.

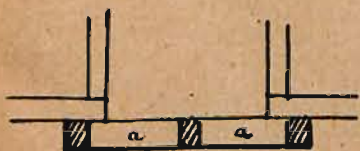

RYS. 81.

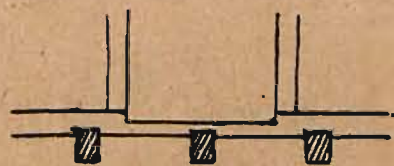

RYS. 80.



RYS. 88.

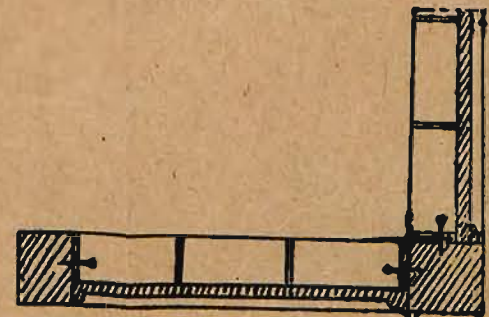

RYS. 82.



RYS. 85.



RYS. 86.



RYS. 87.

BUDOWNICTWO. OGÓLNE.
TABLICA V.

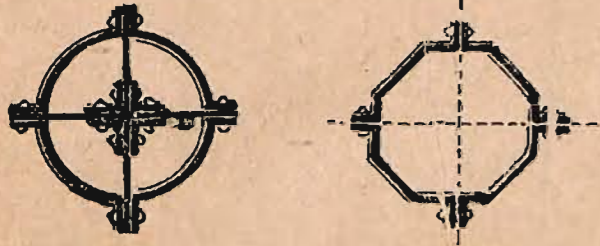
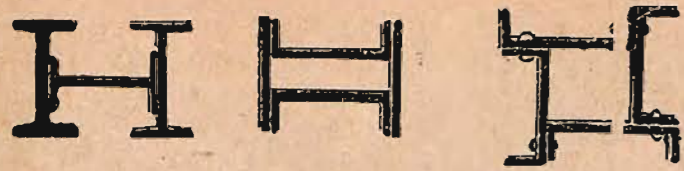

RYS. 89.

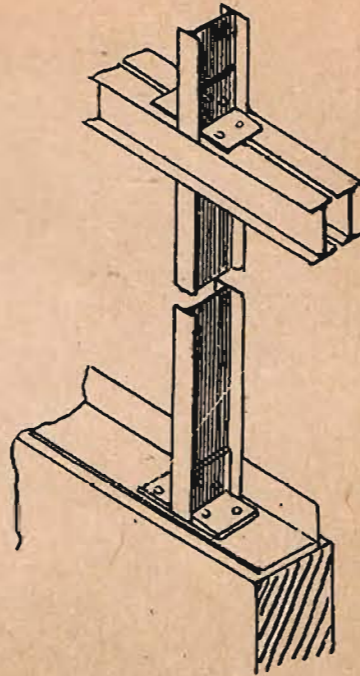

RYS. 90.

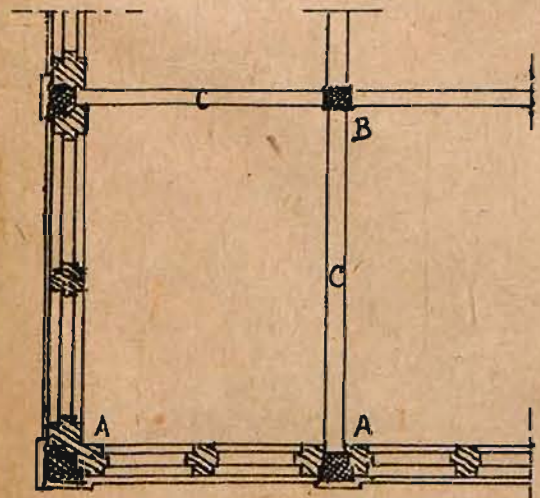
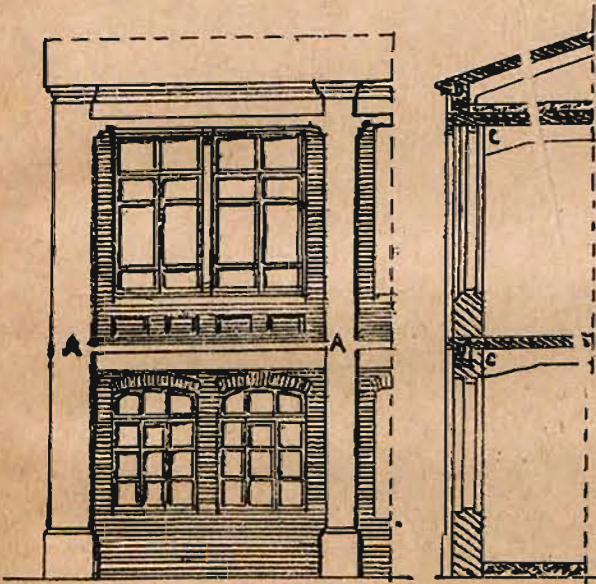
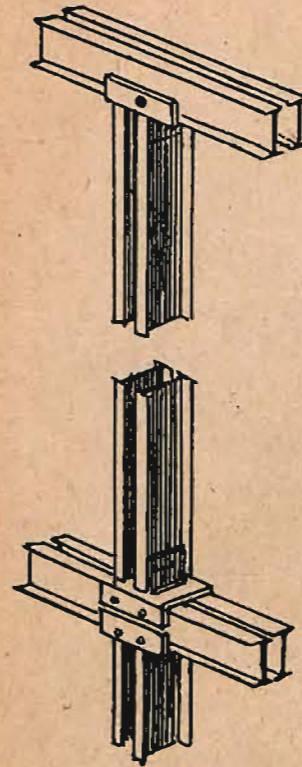

RYS. 94.

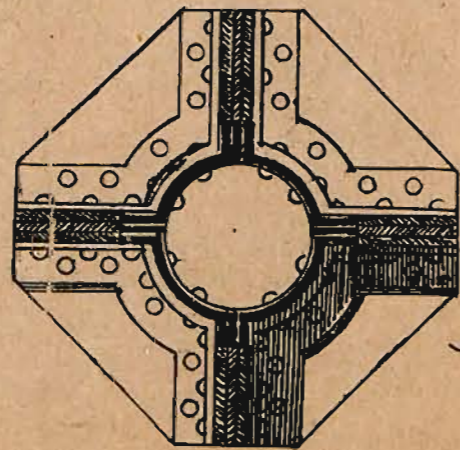
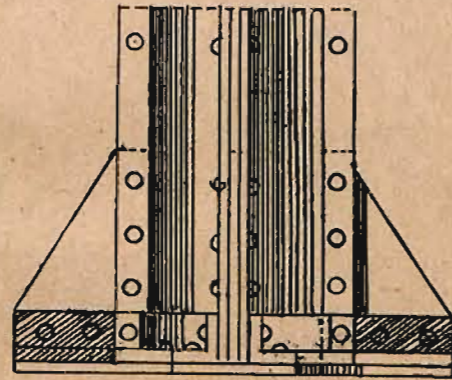

RYS. 92.

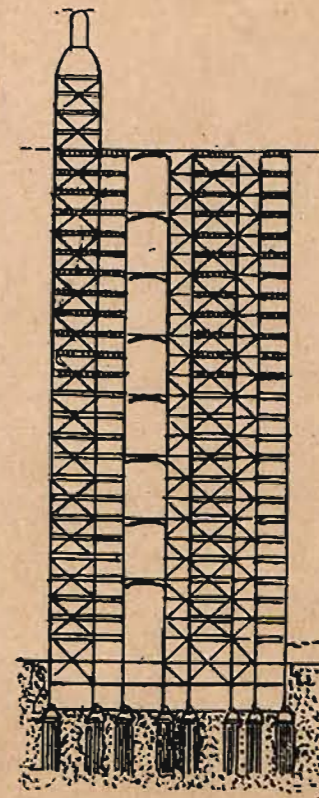
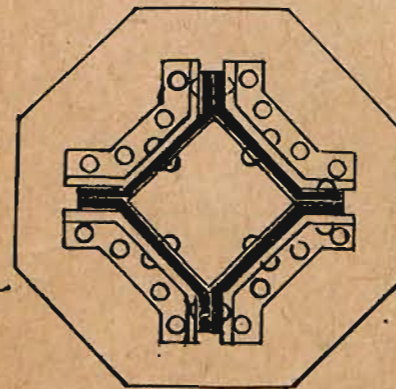
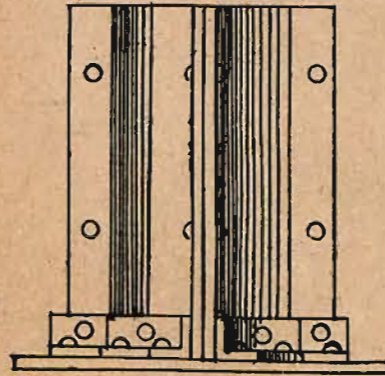

RYS. 91.

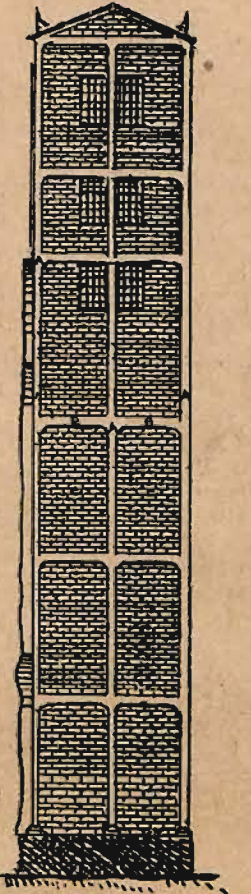

RYS. 96.

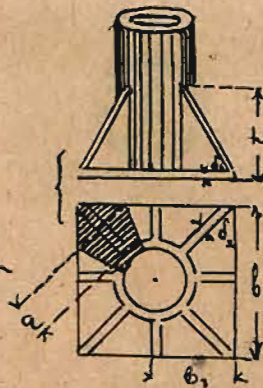

RYS. 93.

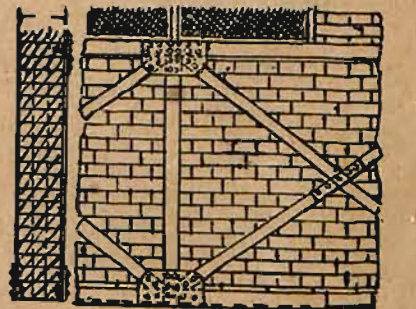



RYS. 97.



RYS. 103.

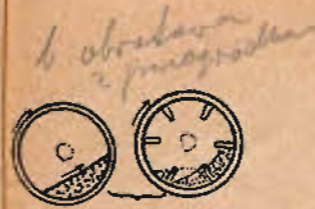

RYS. 108.

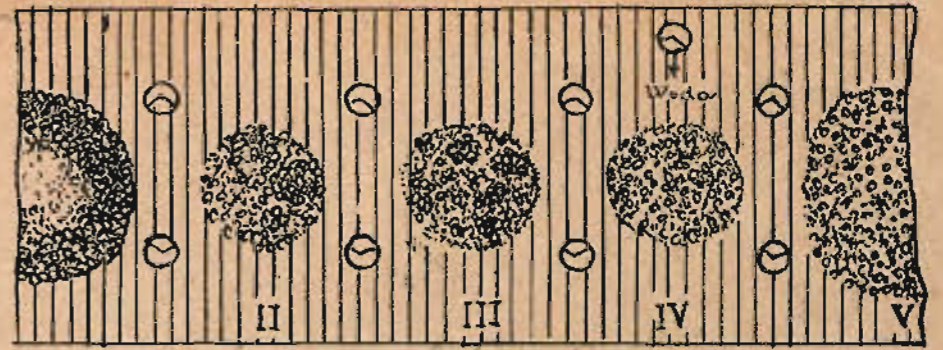

RYS. 100.

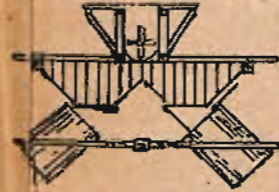

RYS. 111.

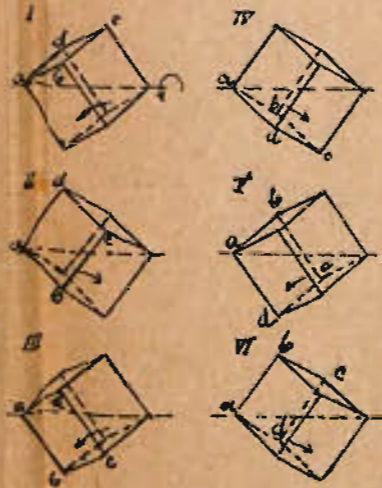
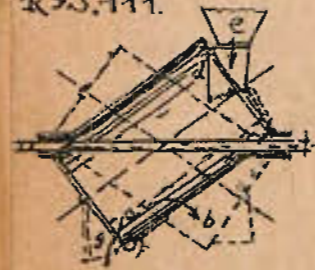

RYS. 110.

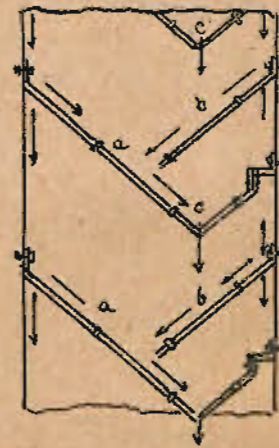

RYS. 114.

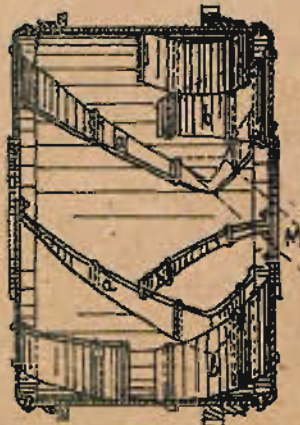

RYS. 113.

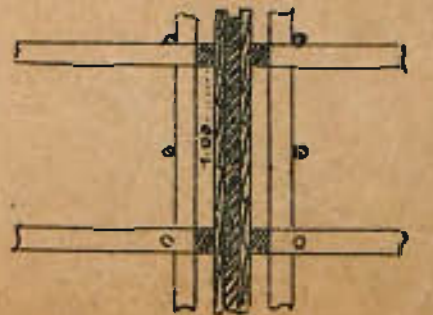
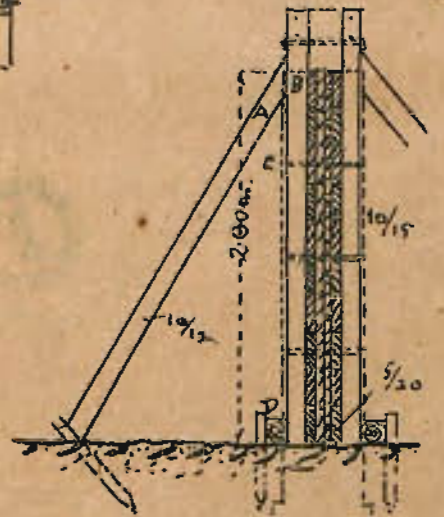

RYS. 117.



RYS. 98.

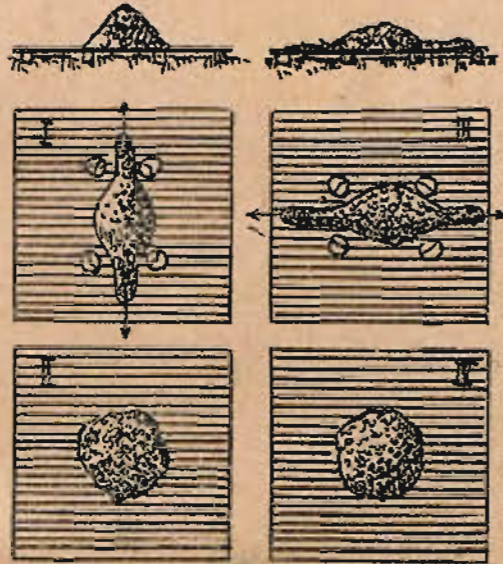

RYS. 106.

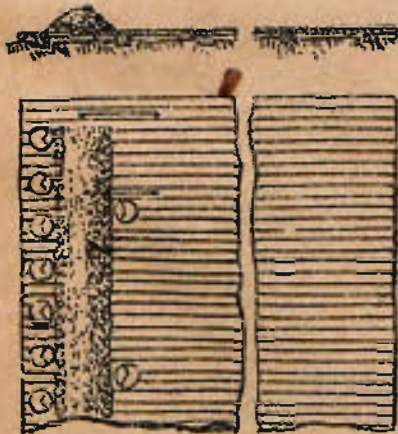

RYS. 99.

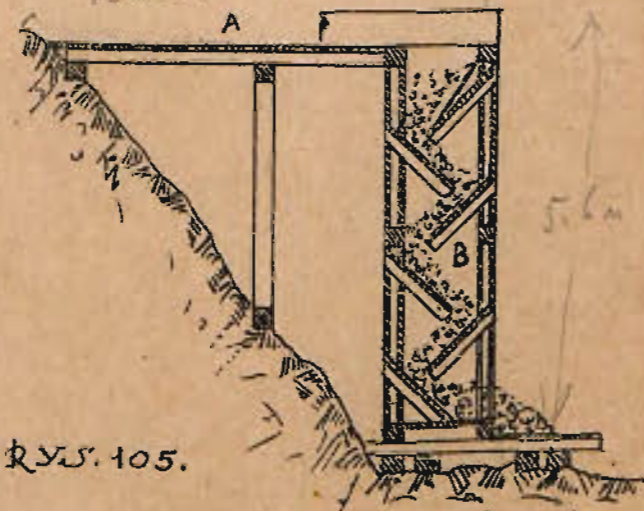

RYS. 105.



RYS. 104.

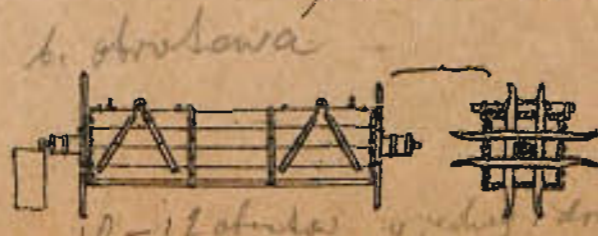

RYS. 107.

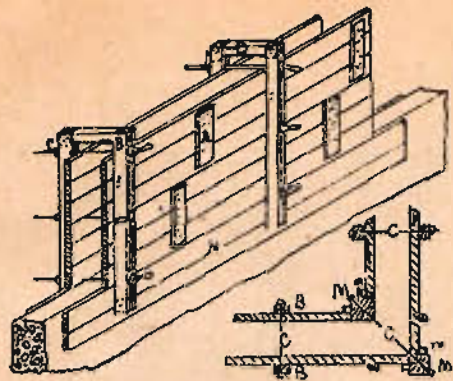

RYS. 118.

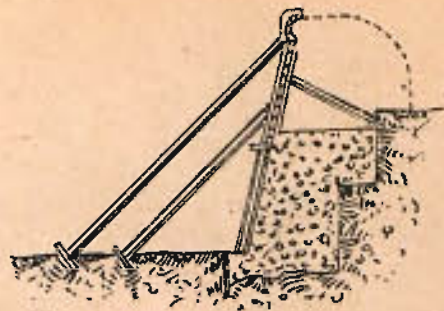

RYS. 119.

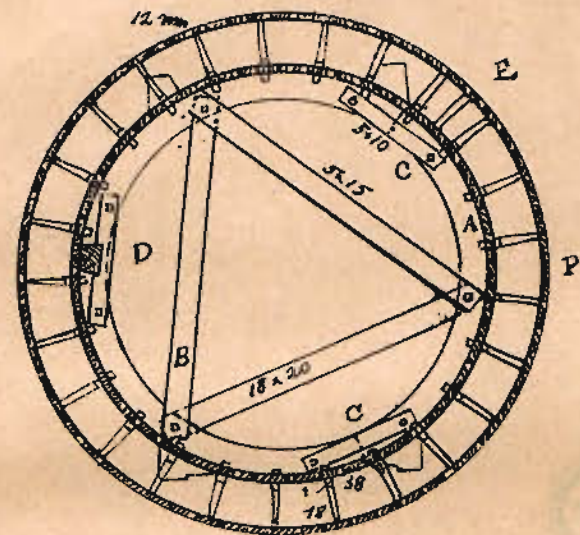

RYS. 123.

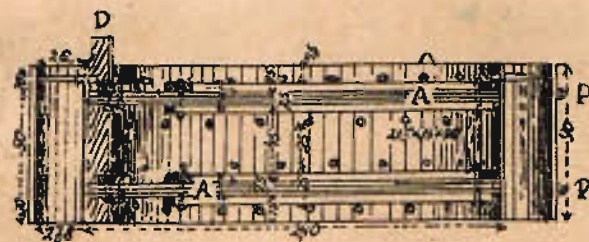

RYS. 130.

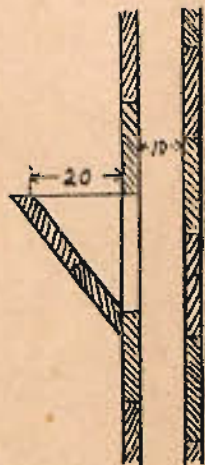
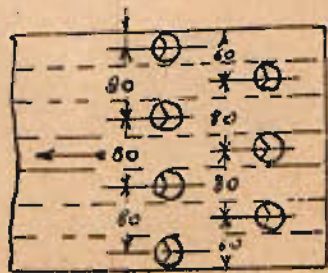

RYS. 127

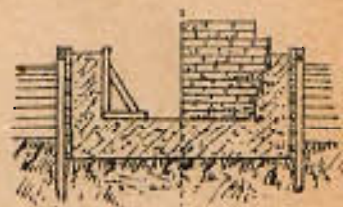

RYS. 128

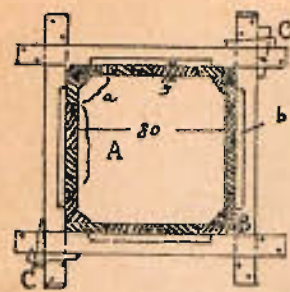

RYS. 120



RYS. 121

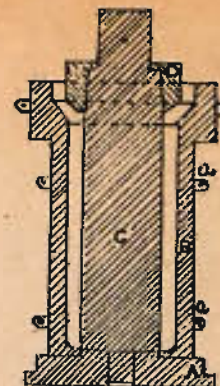

RYS. 122.

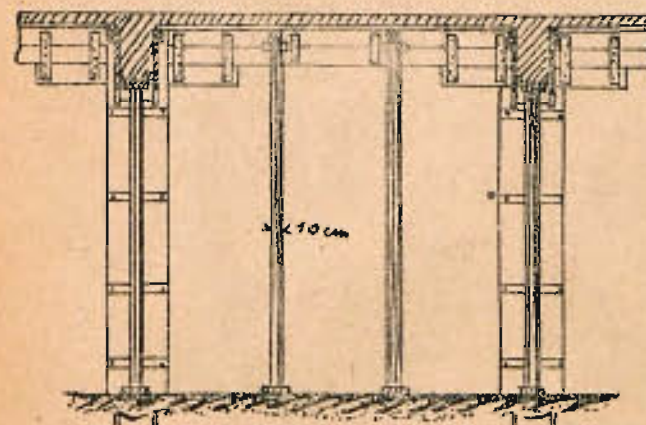

RYS. 124



RYS. 126.

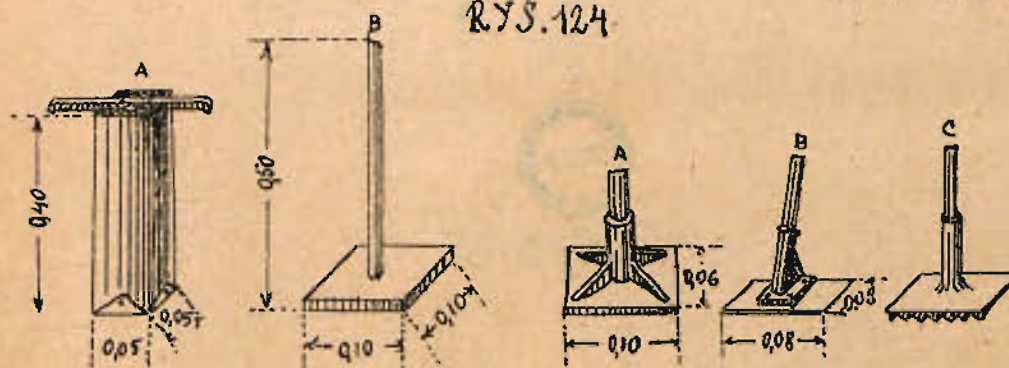

RYS. 129

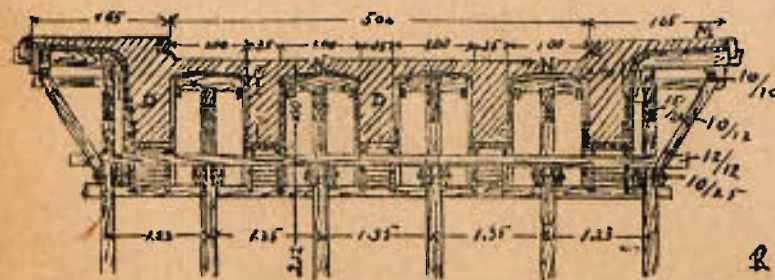

RYS. 125.

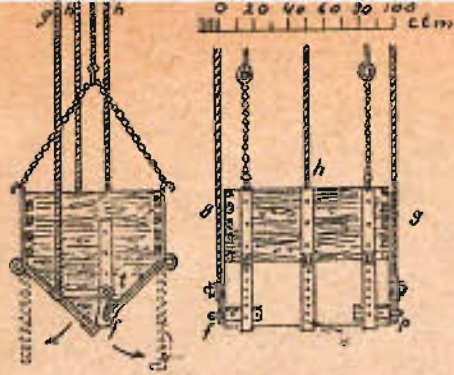

RYS. 131.

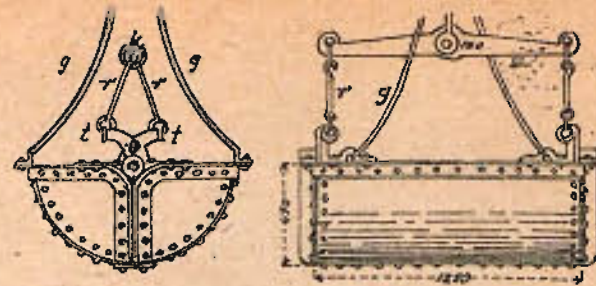

RYS. 132.

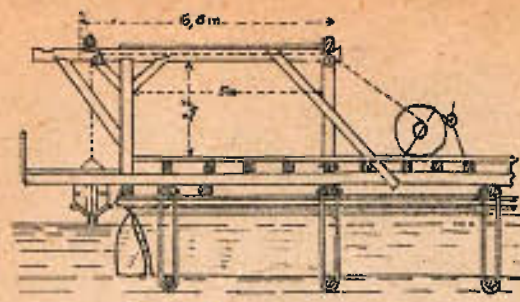

RYS. 133.

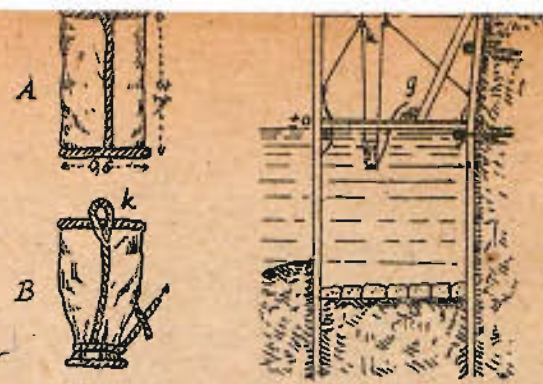

RYS. 134.

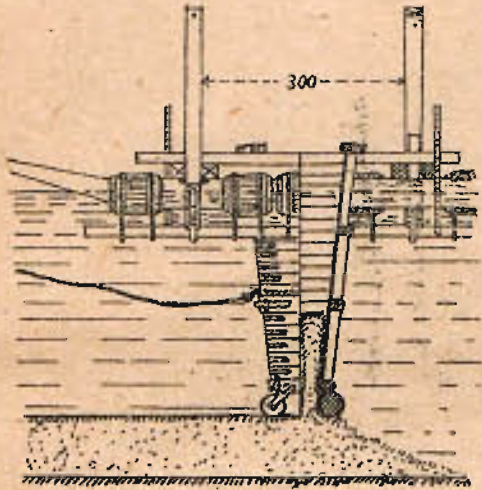

RYS. 136.

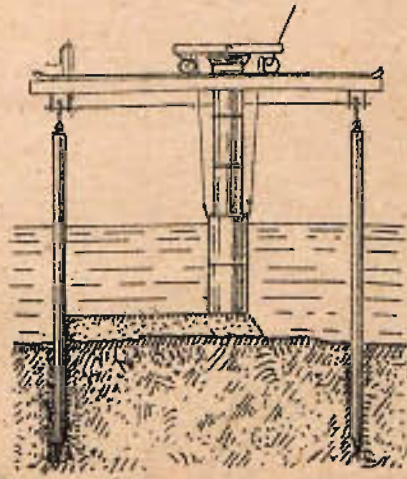

RYS. 137.

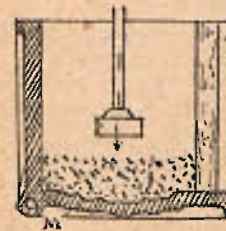

RYS. 138.

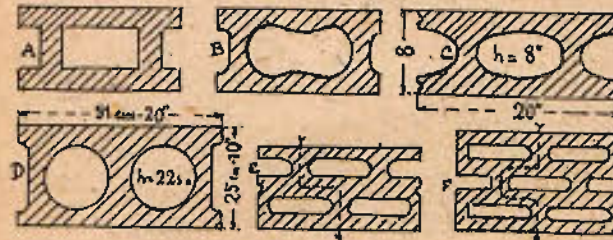
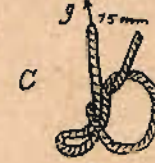

RYS. 139.

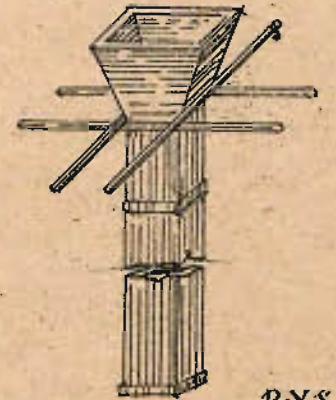

RYS. 135.

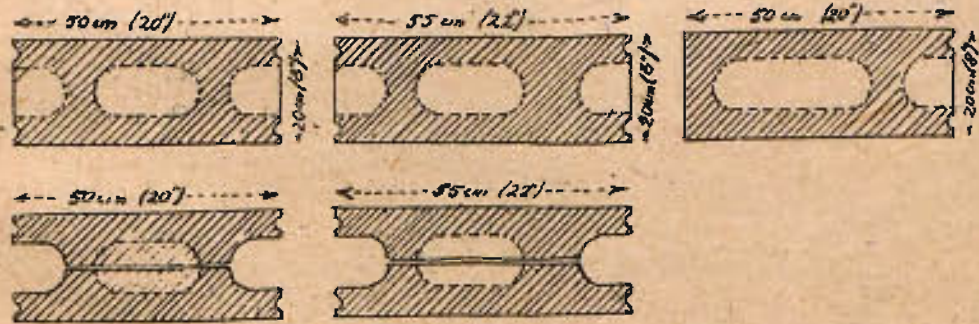

RYS. 141.

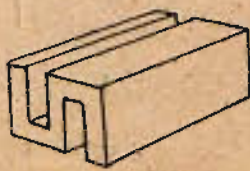
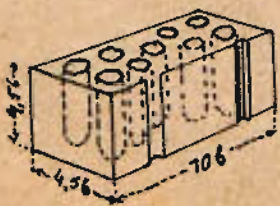

RYS. 142.

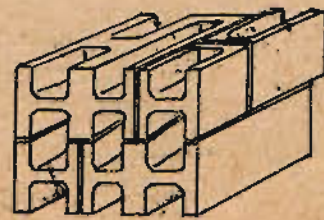

BYDOWNICTWO OGOLNE TABLICE IX.

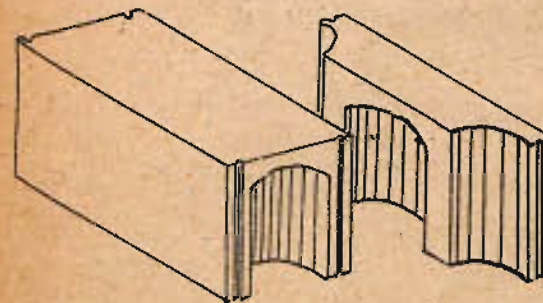

RYS. 140.

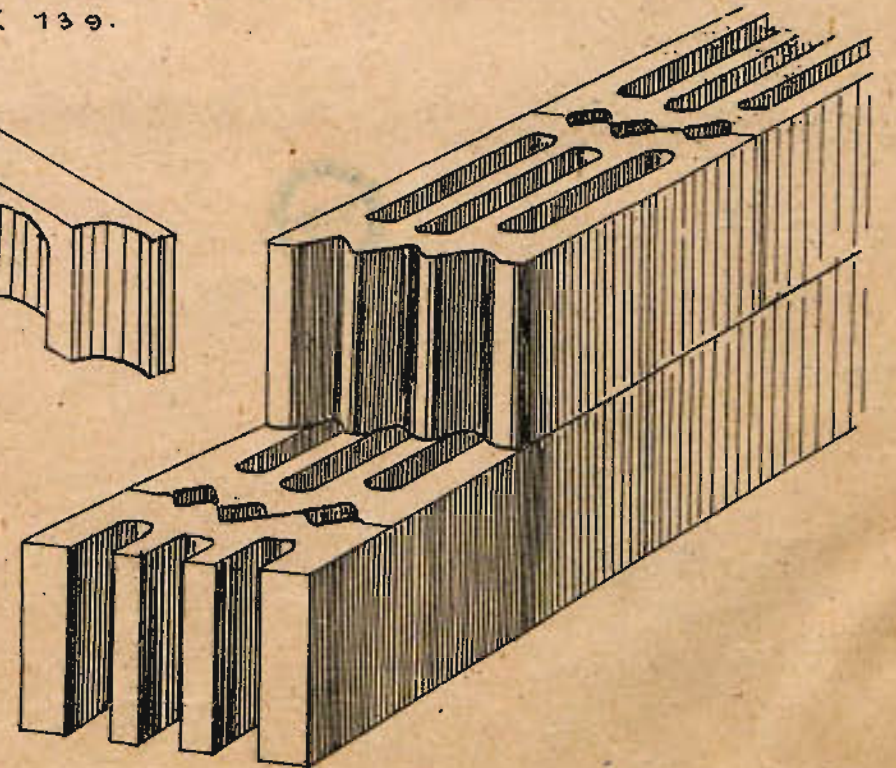

RYS. 143.

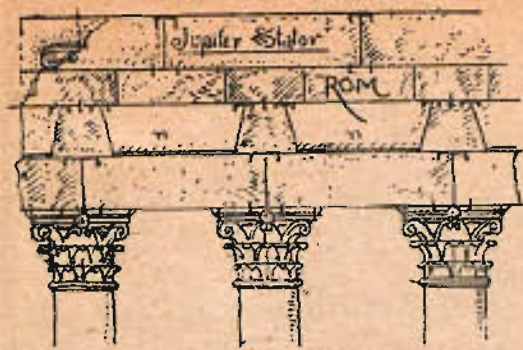

RYS. 156.

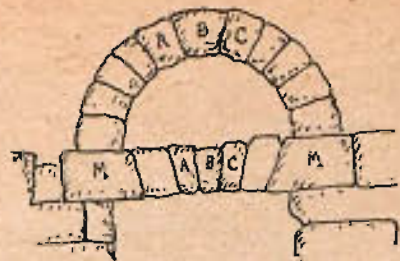

RYS. 158.



RYS. 157.

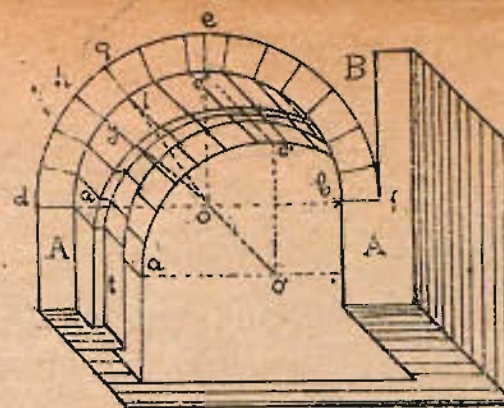

RYS. 159.



RYS. 160.



RYS. 161.

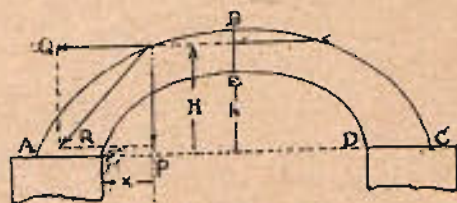

RYS. 164.

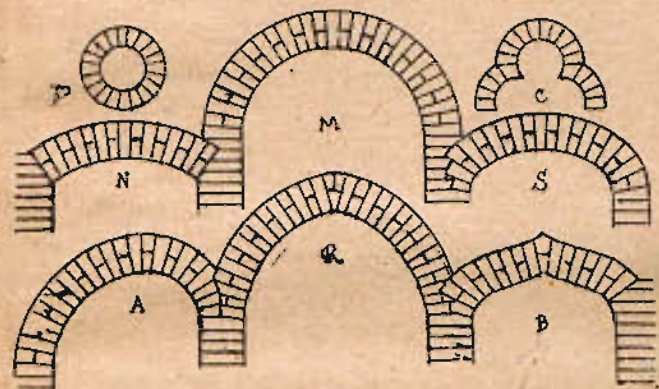

RYS. 162.

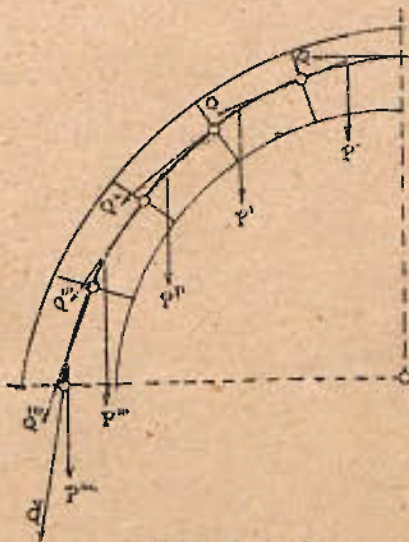

RYS. 165.

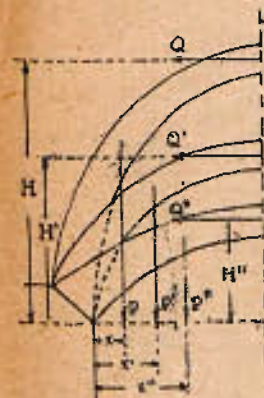

RYS. 166.

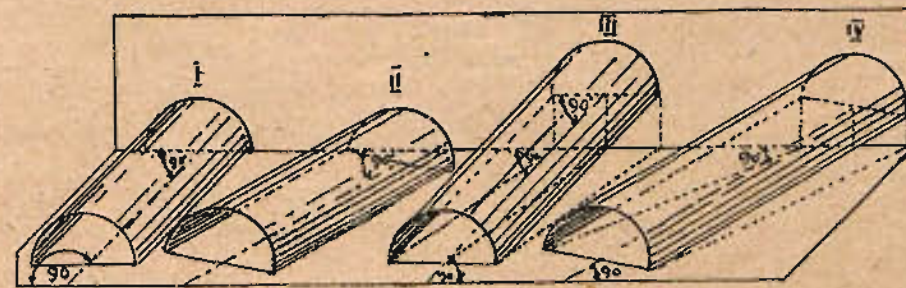

RYS. 163.

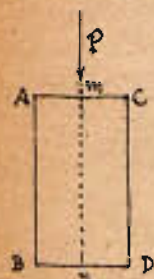

RYS. 169.

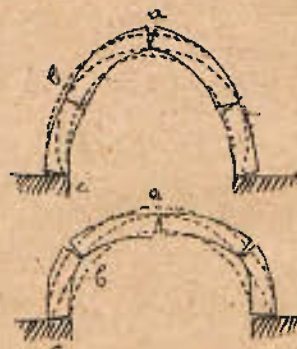

RYS. 170.

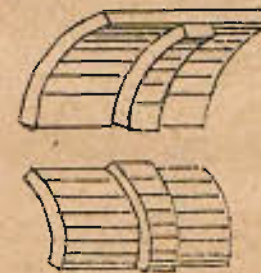

RYS. 171.



RYS. 168.

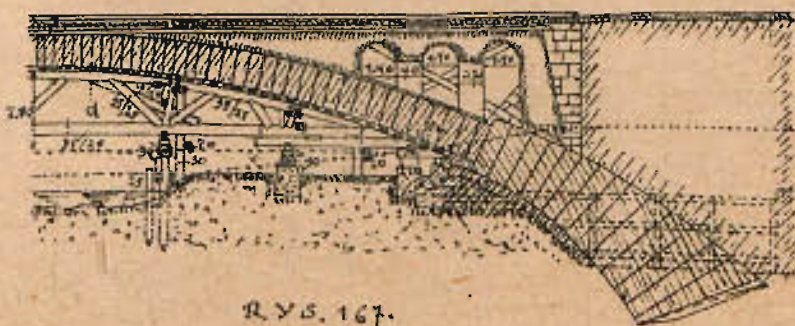

RYS. 167.



RYS. 172.

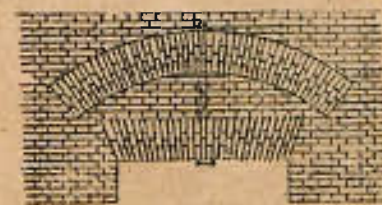

RYS. 173.

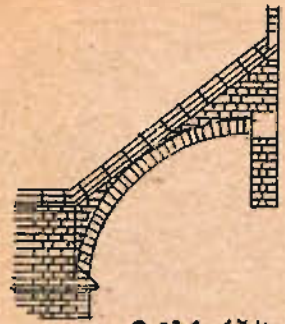

RYS. 174.

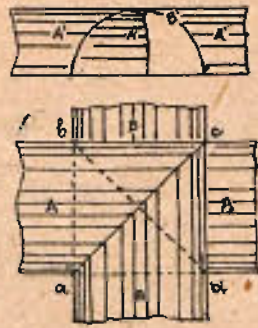

RYS. 175.

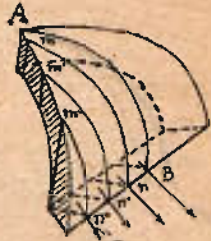

RYS. 183.

*kollekt
do istoty*

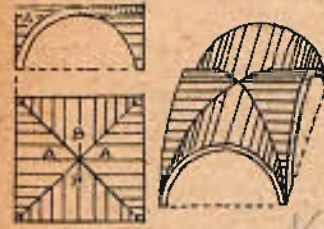

RYS. 177.

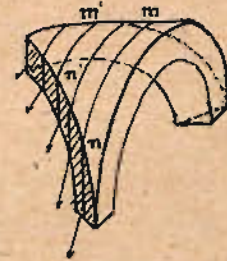

RYS. 185.

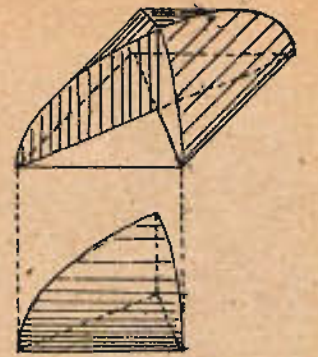

RYS. 178.

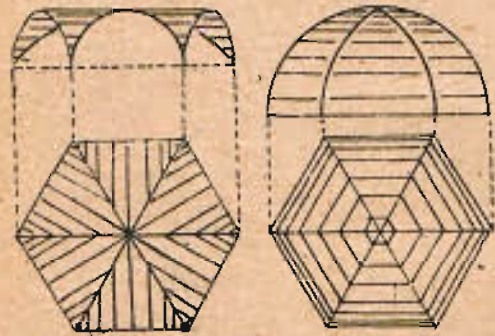

RYS. 180.

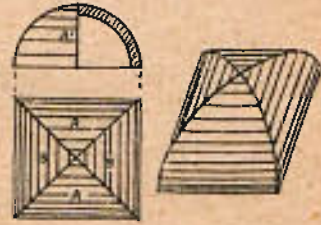

RYS. 176.

Wariant

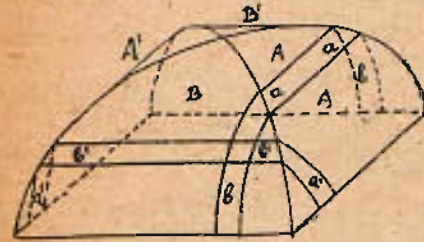

RYS. 184.

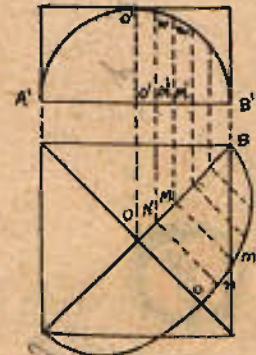

RYS. 188.

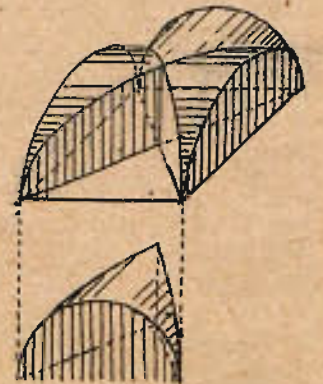

RYS. 179.

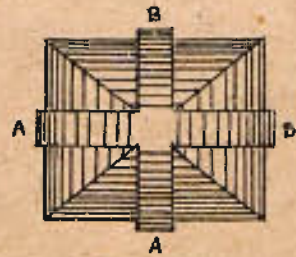

RYS. 190.

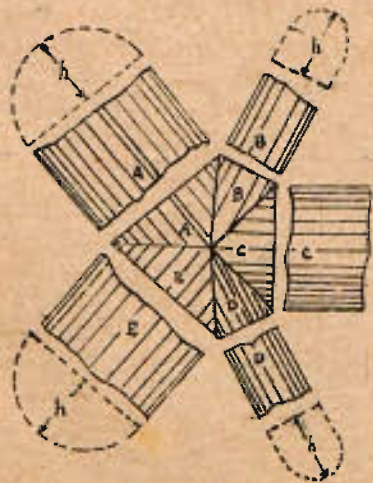

RYS. 181.

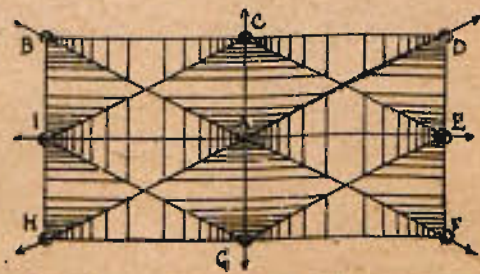

RYS. 187.

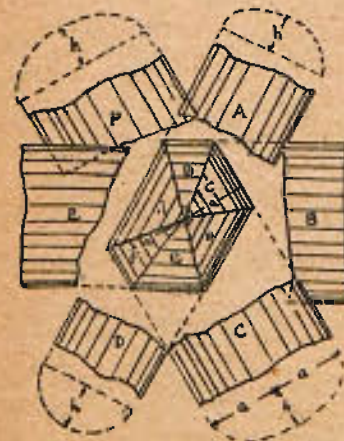

RYS. 182.



RYS. 186.

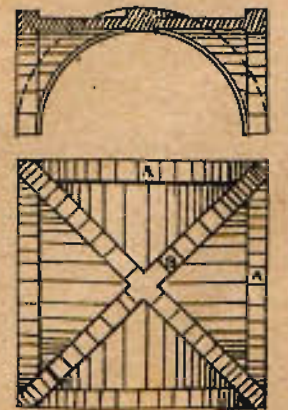

RYS. 189.

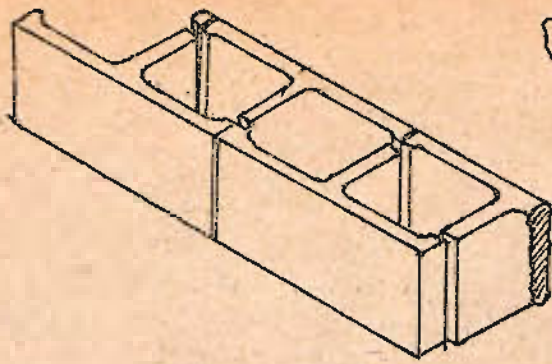

RYS. 144.

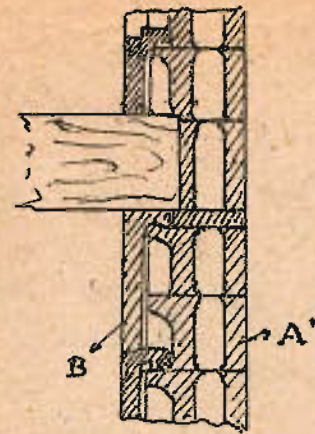
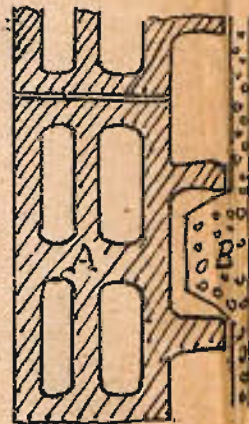
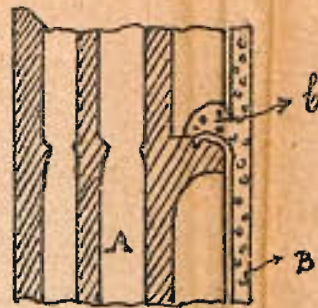
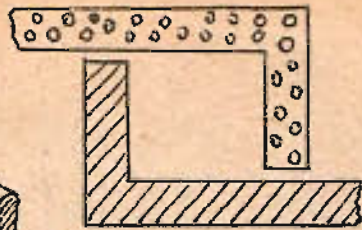

RYS. 147.

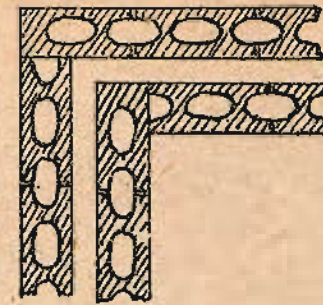

RYS. 148.

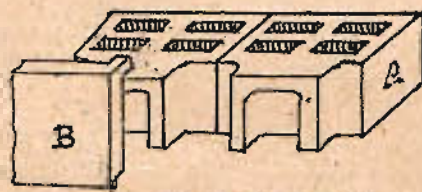

RYS. 146.

RYS. 145.

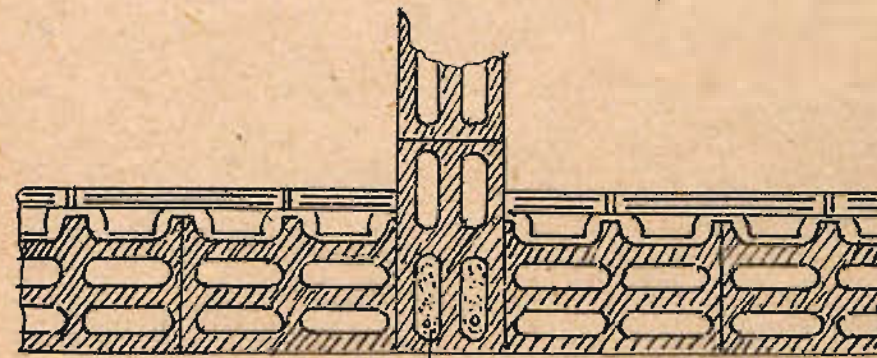

RYS. 152.

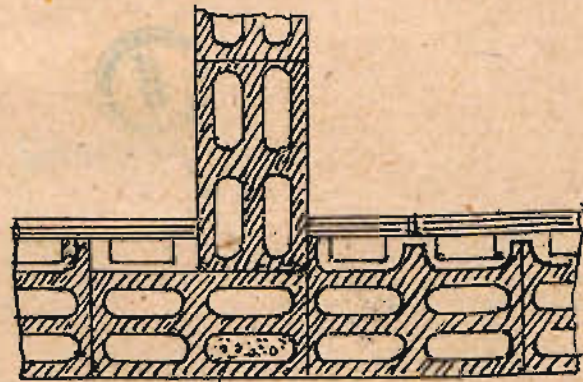

RYS. 153.

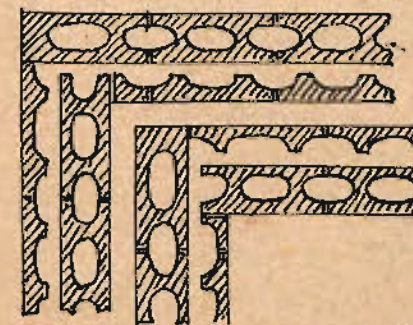

RYS. 149.

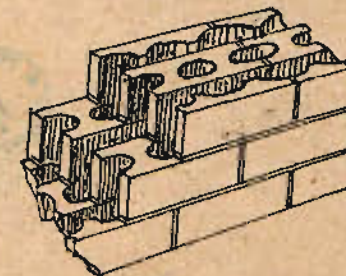

RYS. 150.

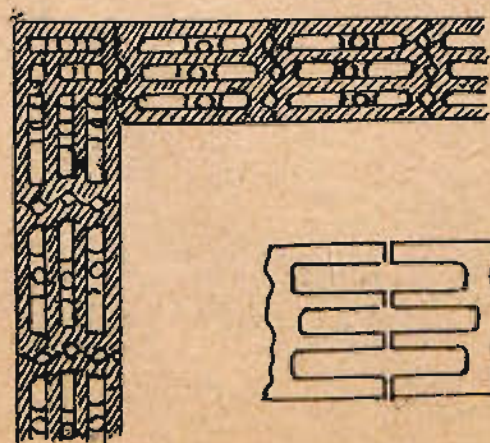

RYS. 151.

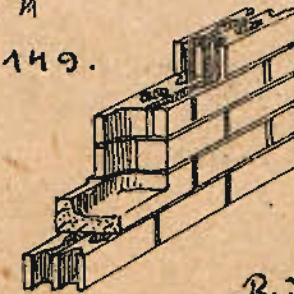
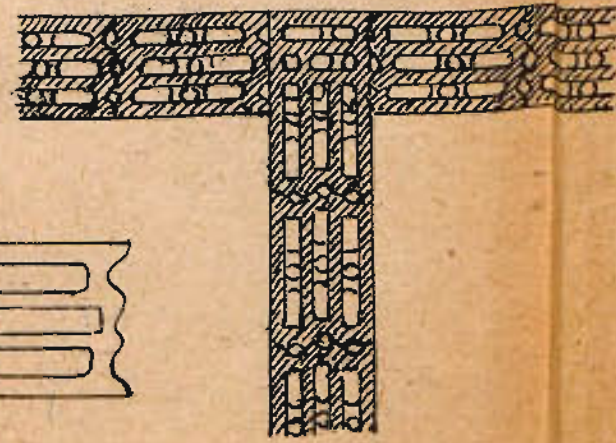

RYS. 154.

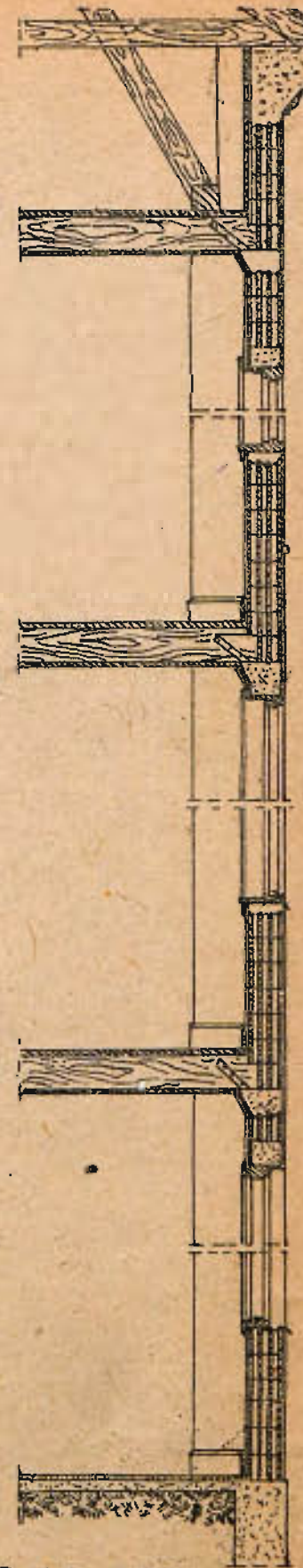

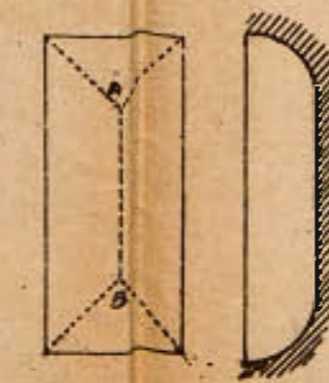
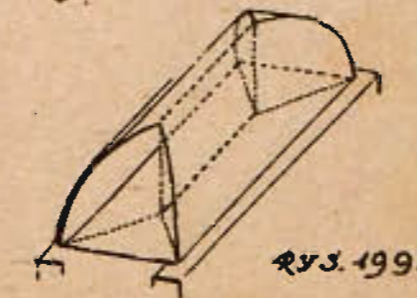
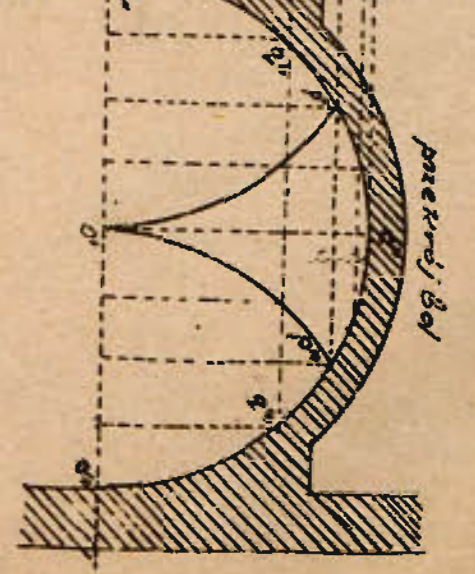
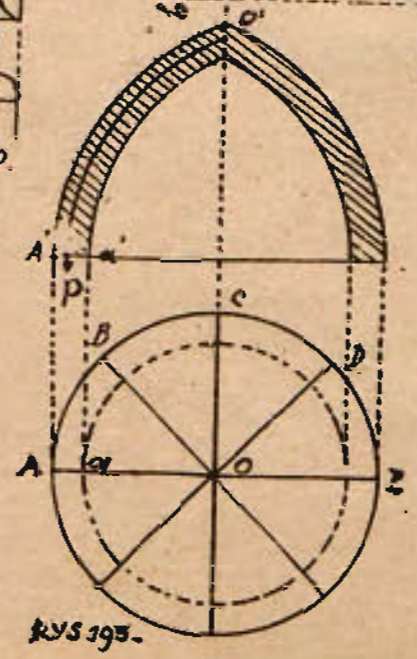
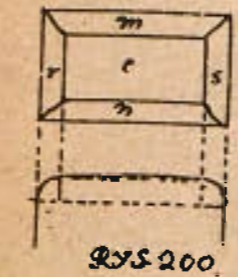
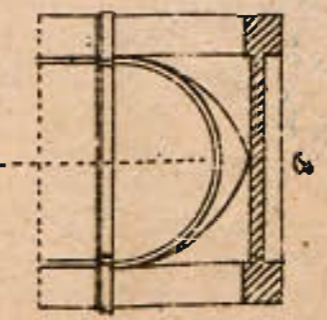
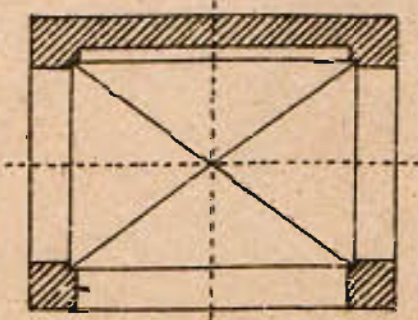
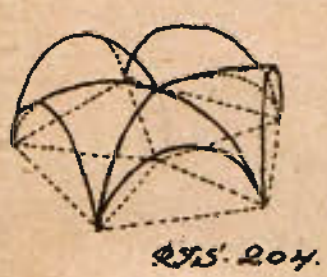
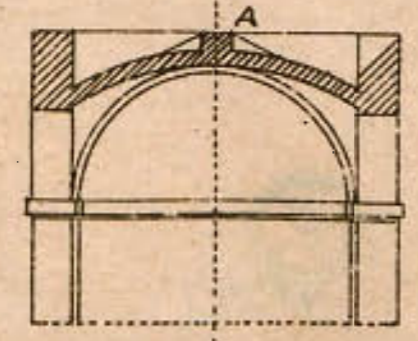
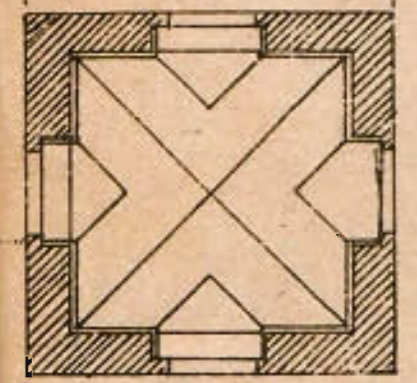
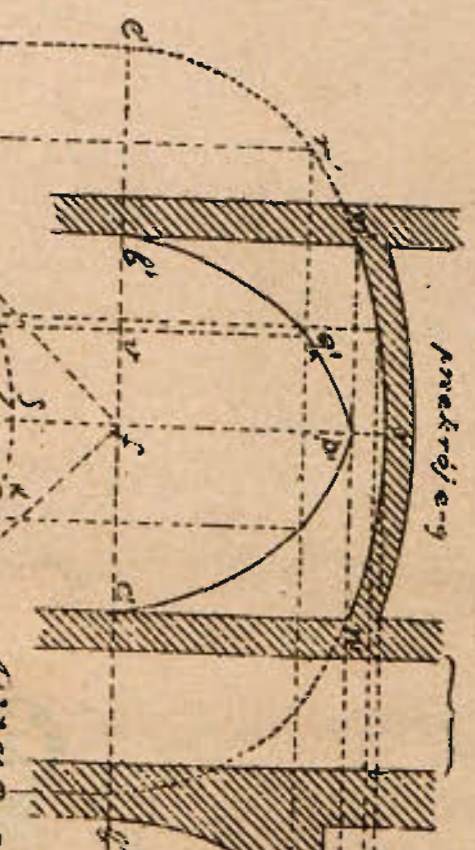
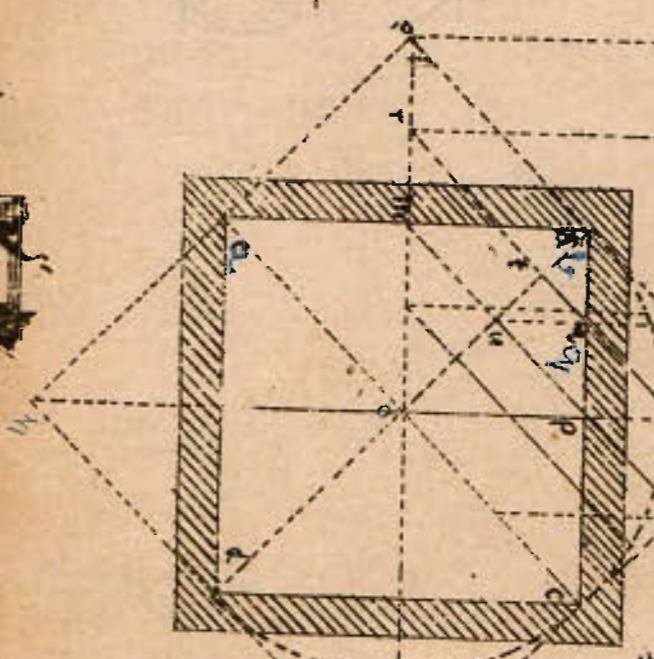
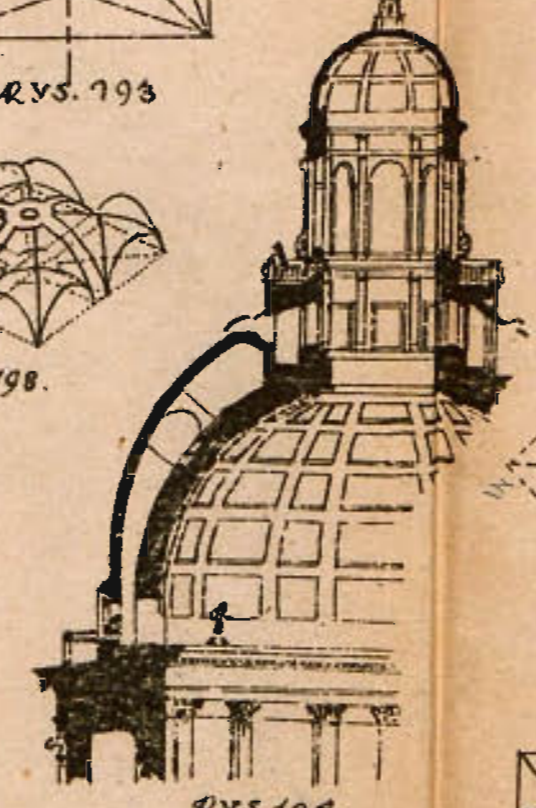
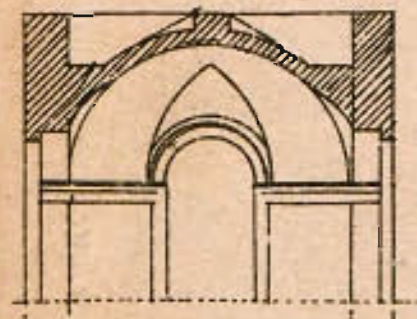
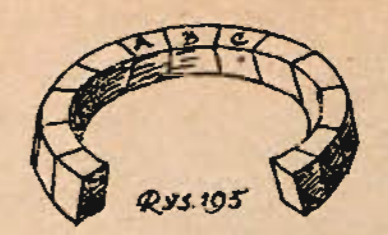
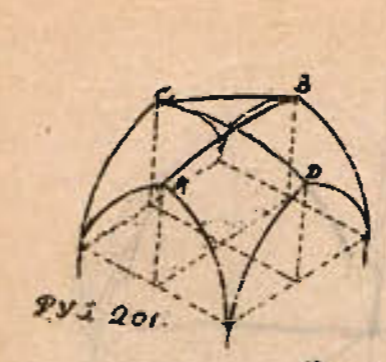
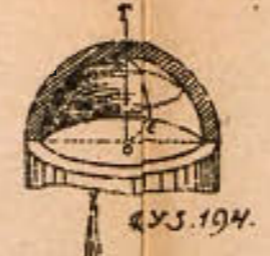
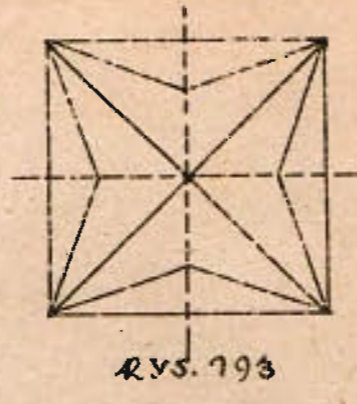
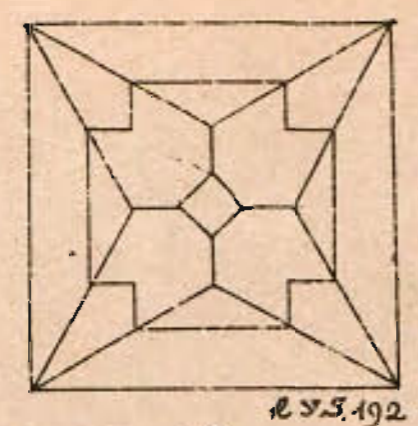
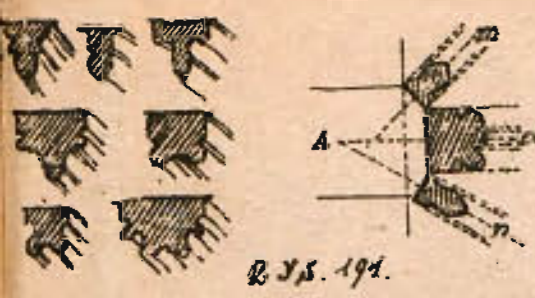

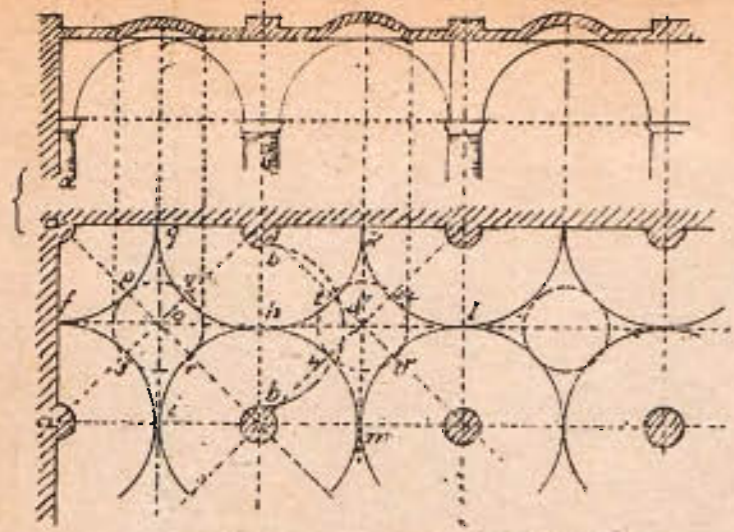

RYS. 209.



RYS. 208.

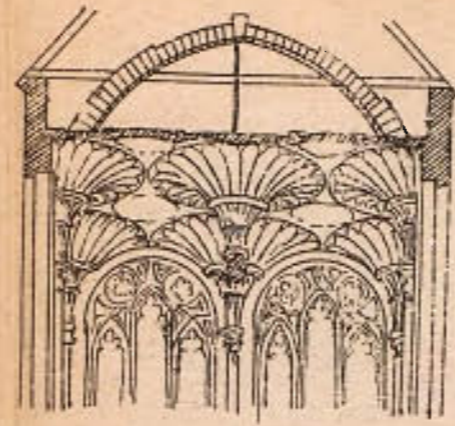

RYS. 211.



RYS. 215.

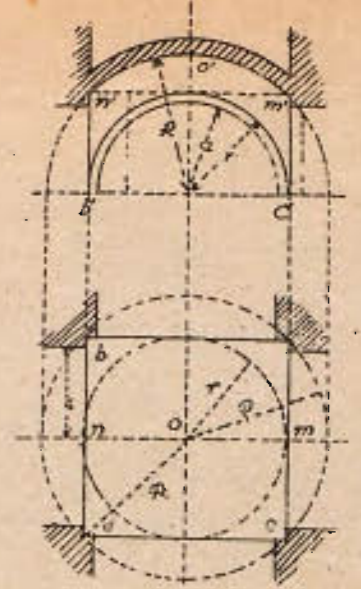

RYS. 216.

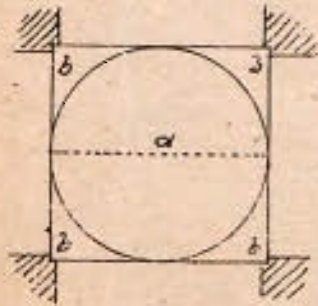

RYS. 212.



RYS. 213.

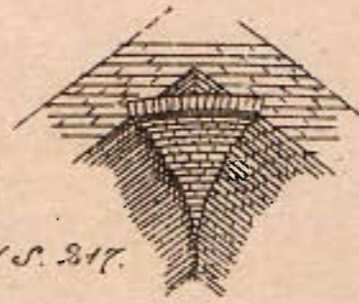

RYS. 217.

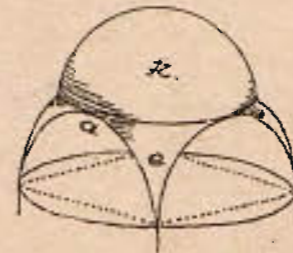

RYS. 214.

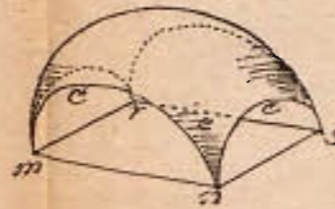
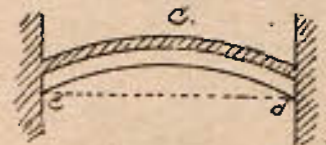

RYS. 213.

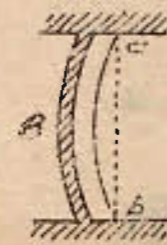

RYS. 221.

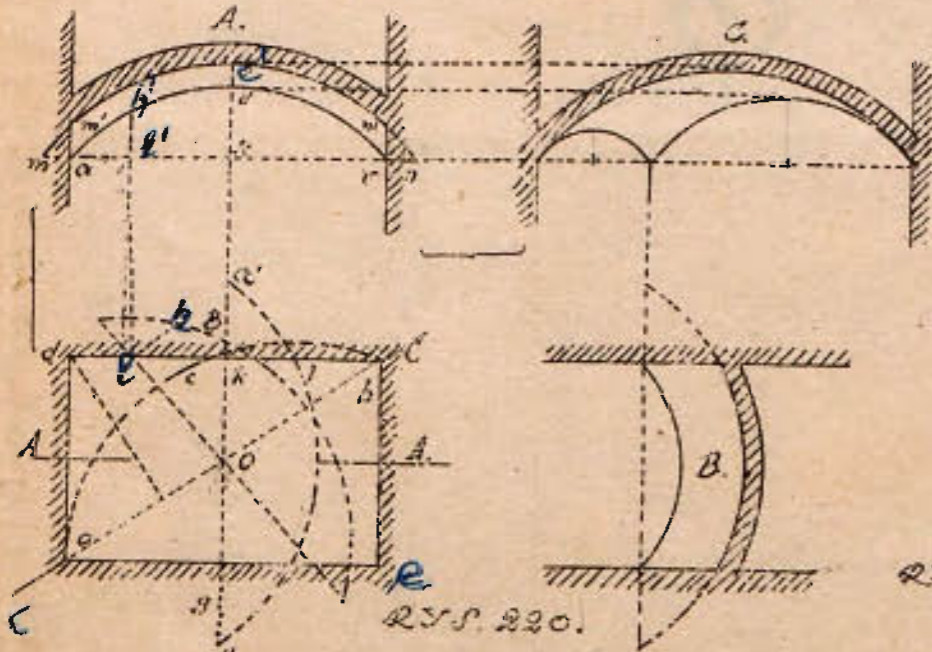
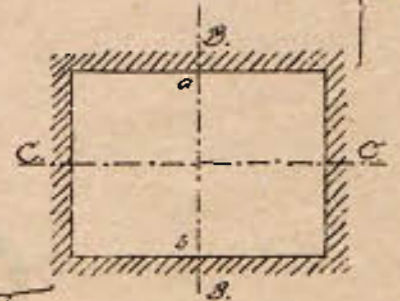

RYS. 220.

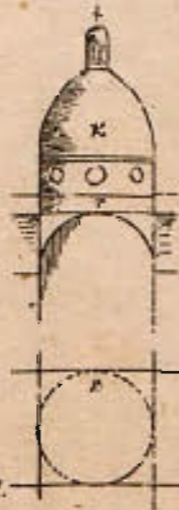

RYS. 219.

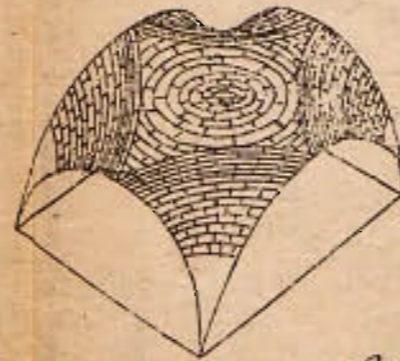

RYS. 210.



RYS. 222.

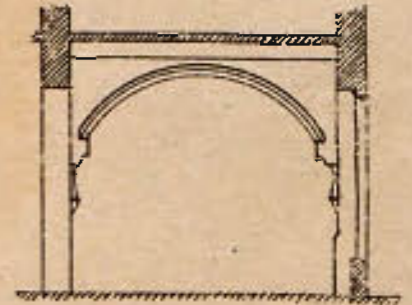

BUDOWNICTWO OGÓLNE. TABLICA XII.

two rucne sklopy zagradowego

*n. d. = 29
m = 2*

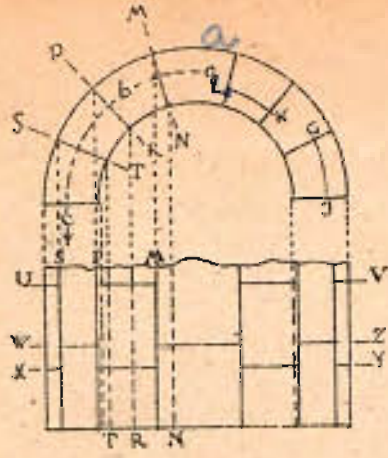

RYS. 223.

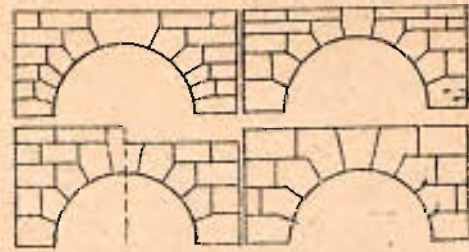

RYS. 224.



RYS. 225.

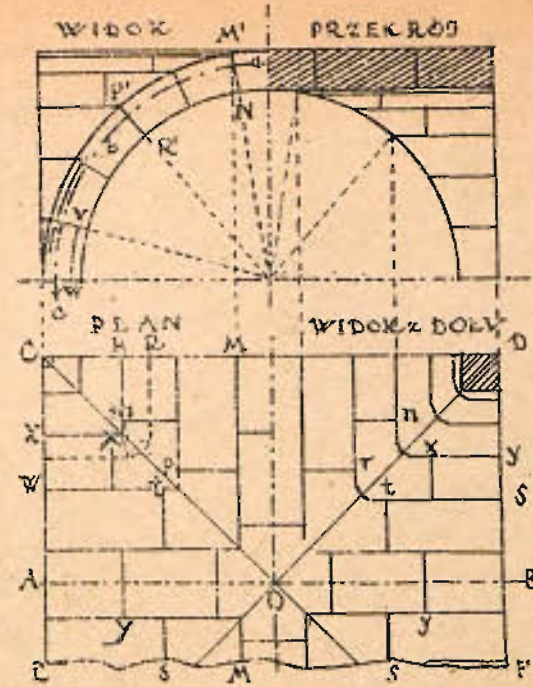

RYS. 226.

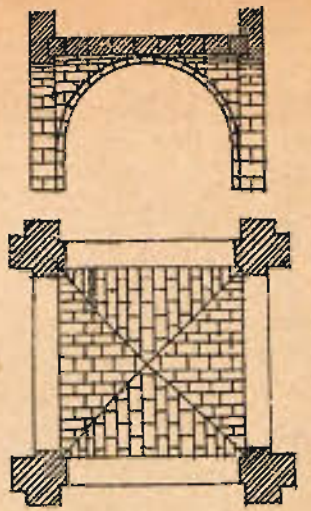

RYS. 227.

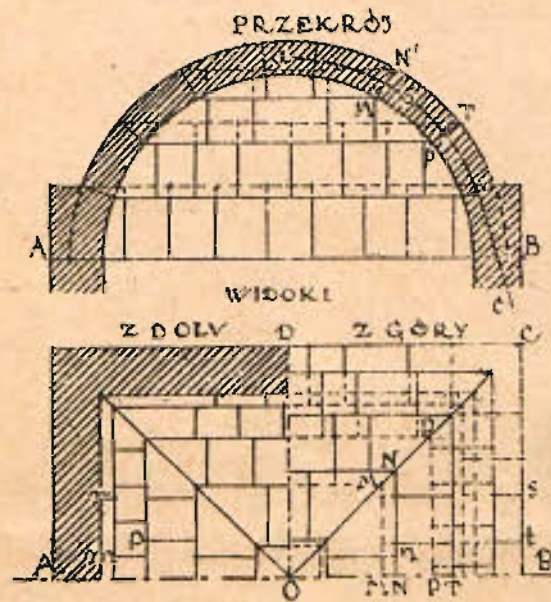

RYS. 229.

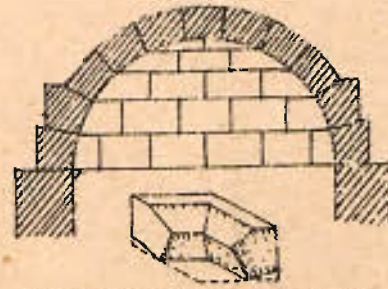

RYS. 228.

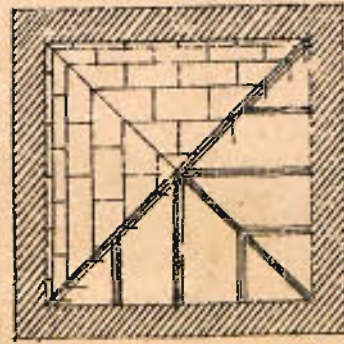

RYS. 230.

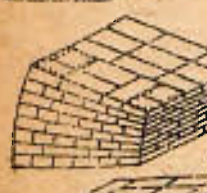
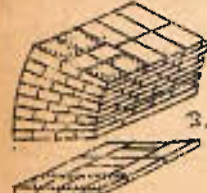
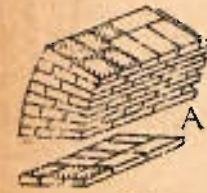
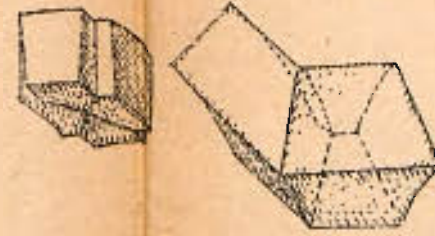

RYS. 235.



RYS. 236.

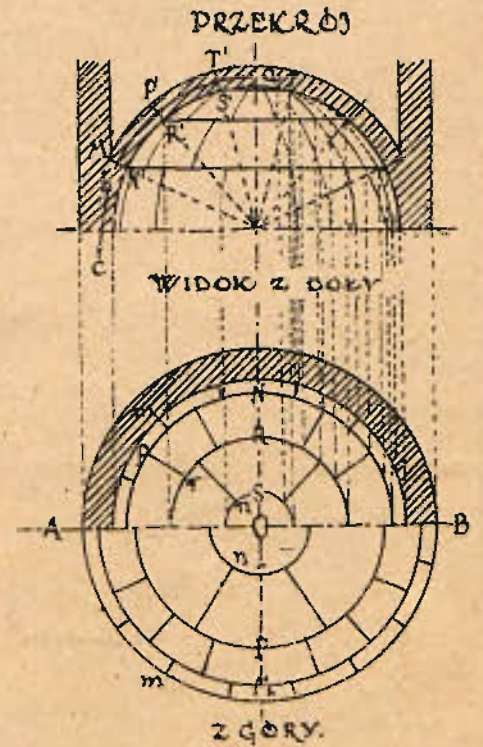

RYS. 231.

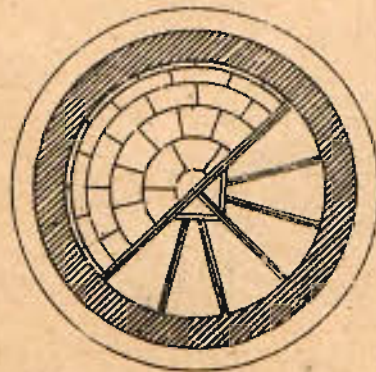

RYS. 232.



RYS. 233.

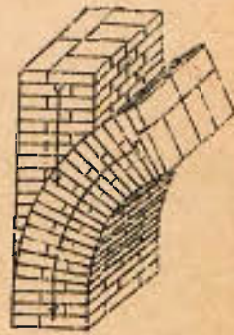

RYS. 234.



RYS. 237.

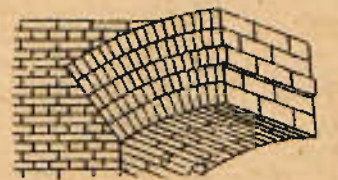

RYS. 238.

BUDOWNICTWO OGÓLNE.

Tablica bis.

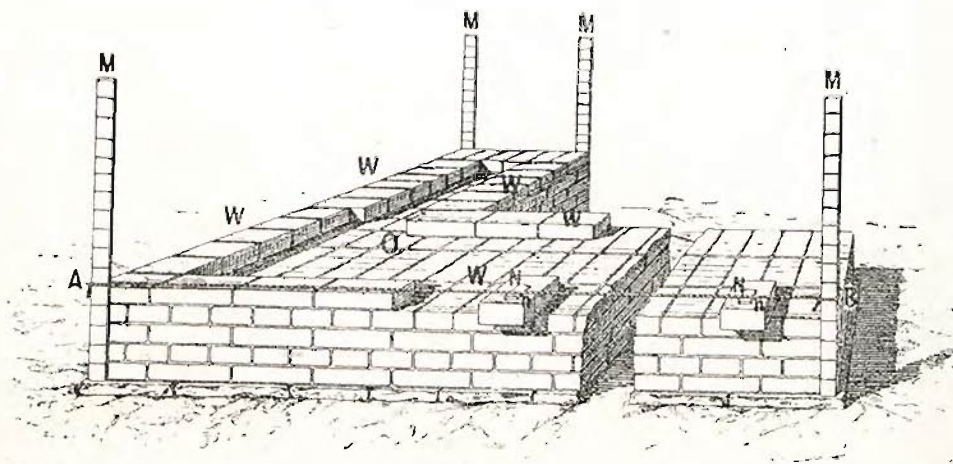

Rys. 41.

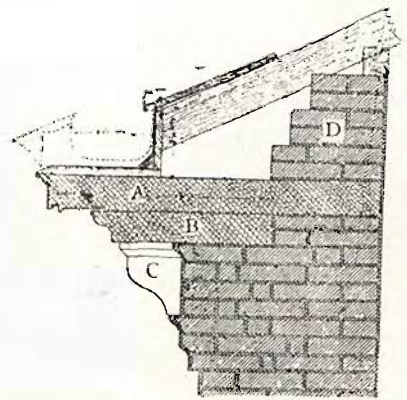

Rys. 58.

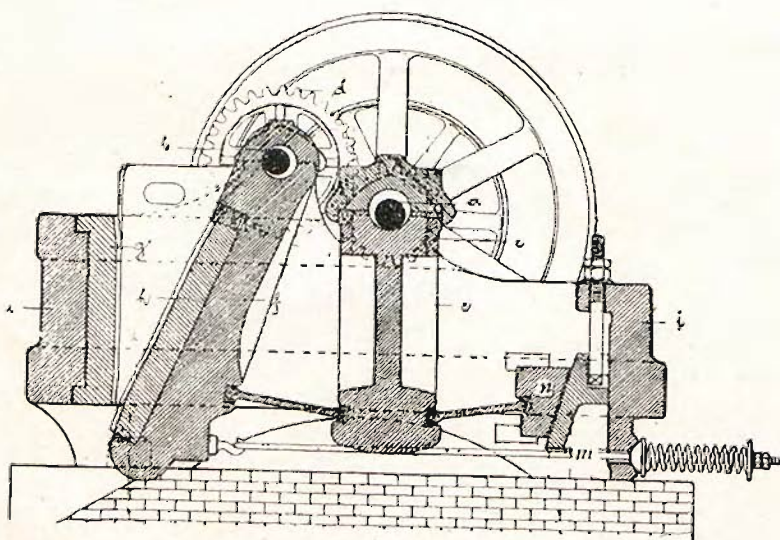

Rys. 101.

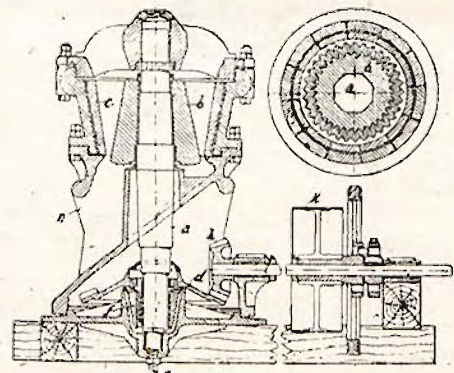

Rys. 102.

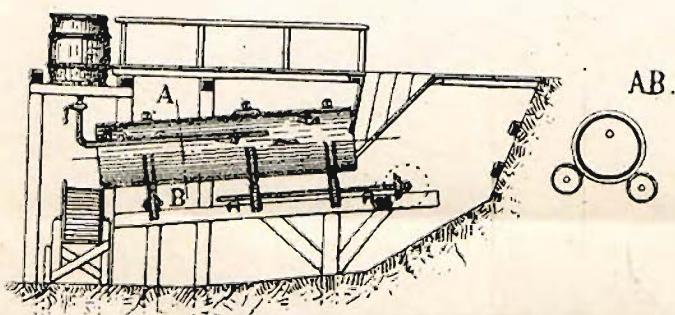

Rys. 109.

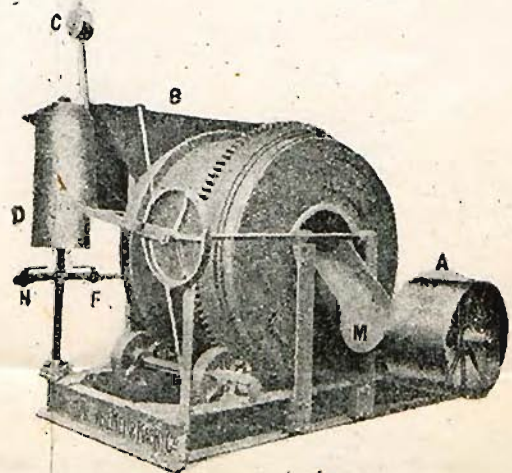

Rys. 112.
Betonierka Ransoma.

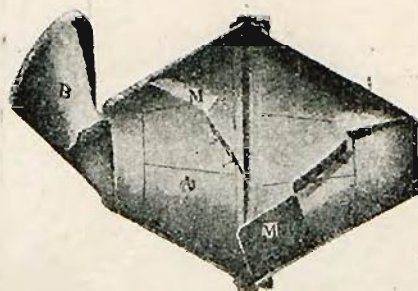

Rys. 115.
Betonierka Smith'a

TABL. A

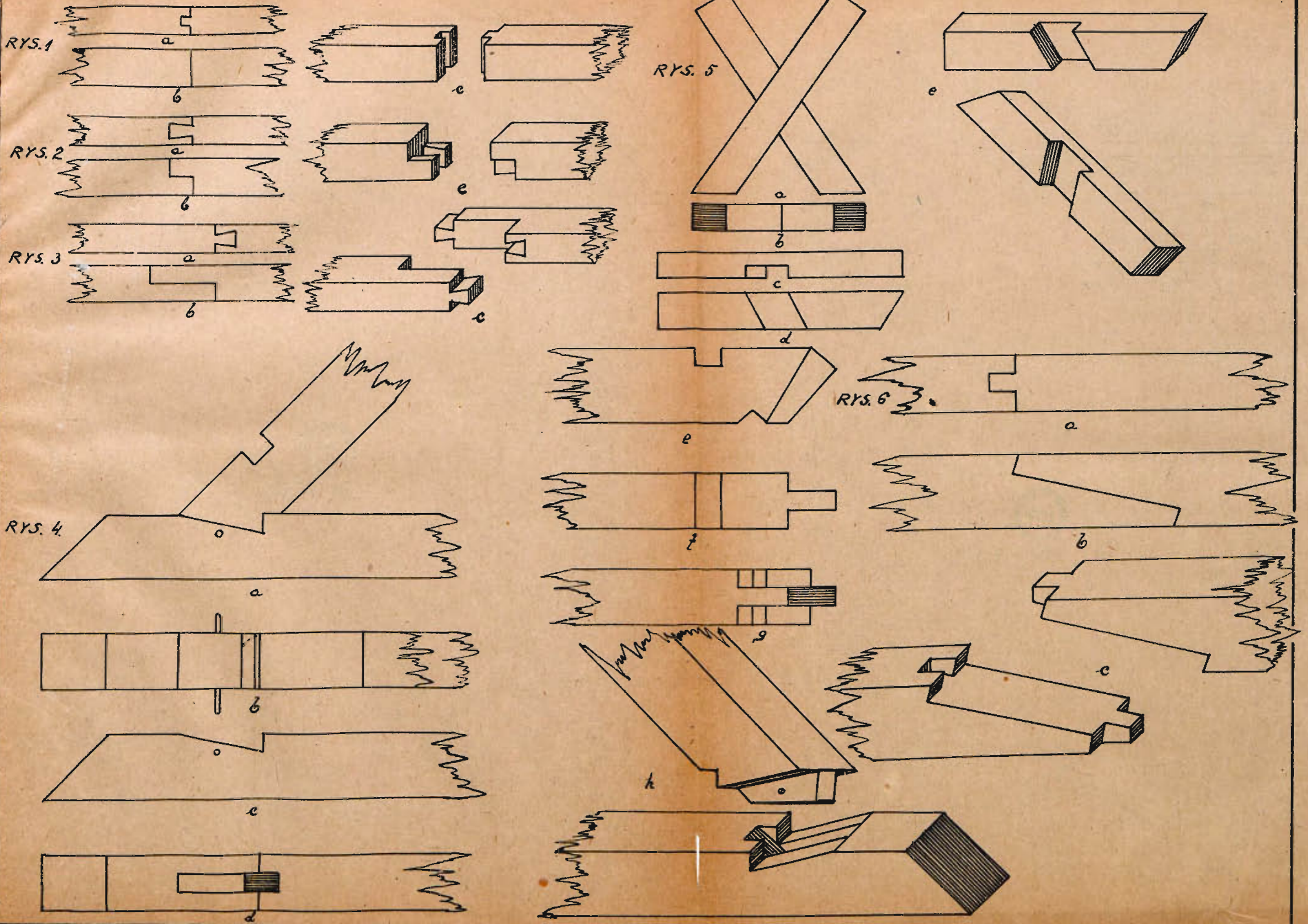

TABL. B.

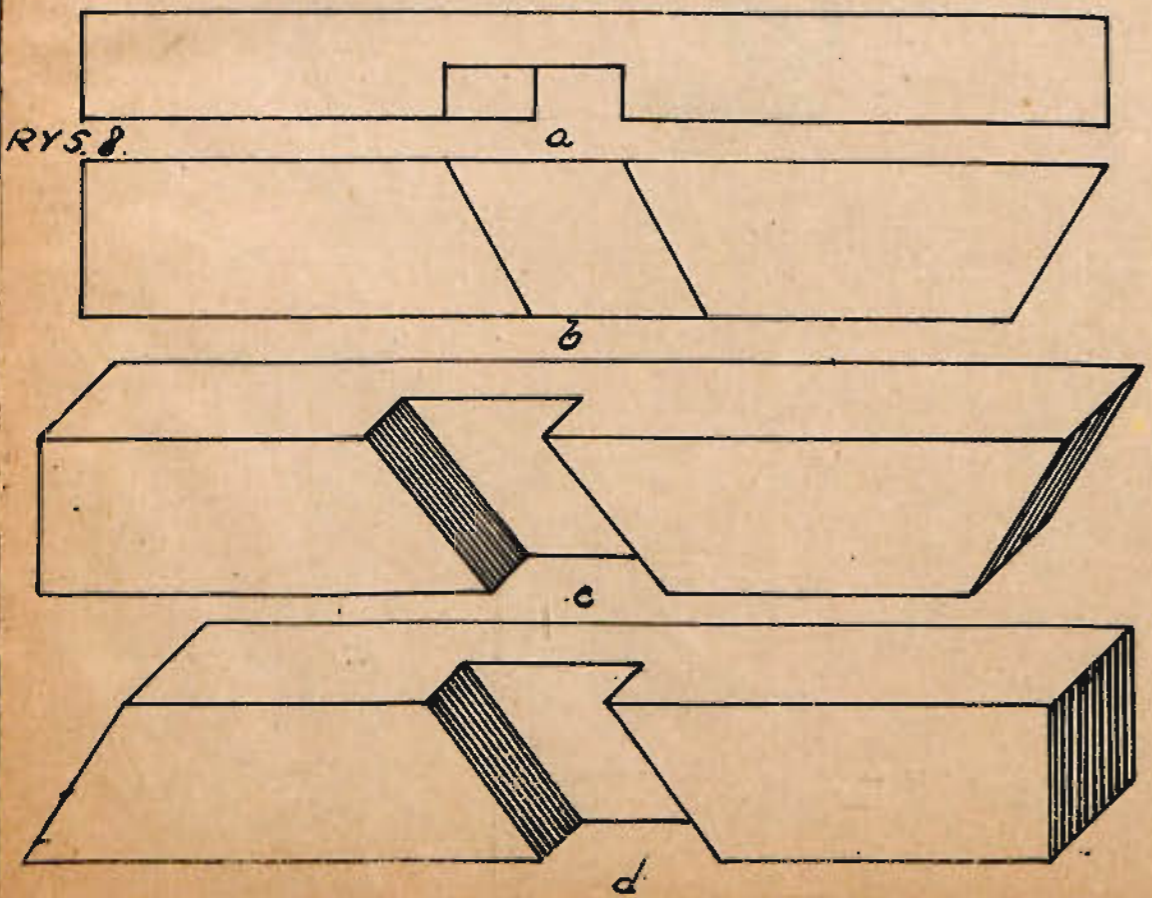
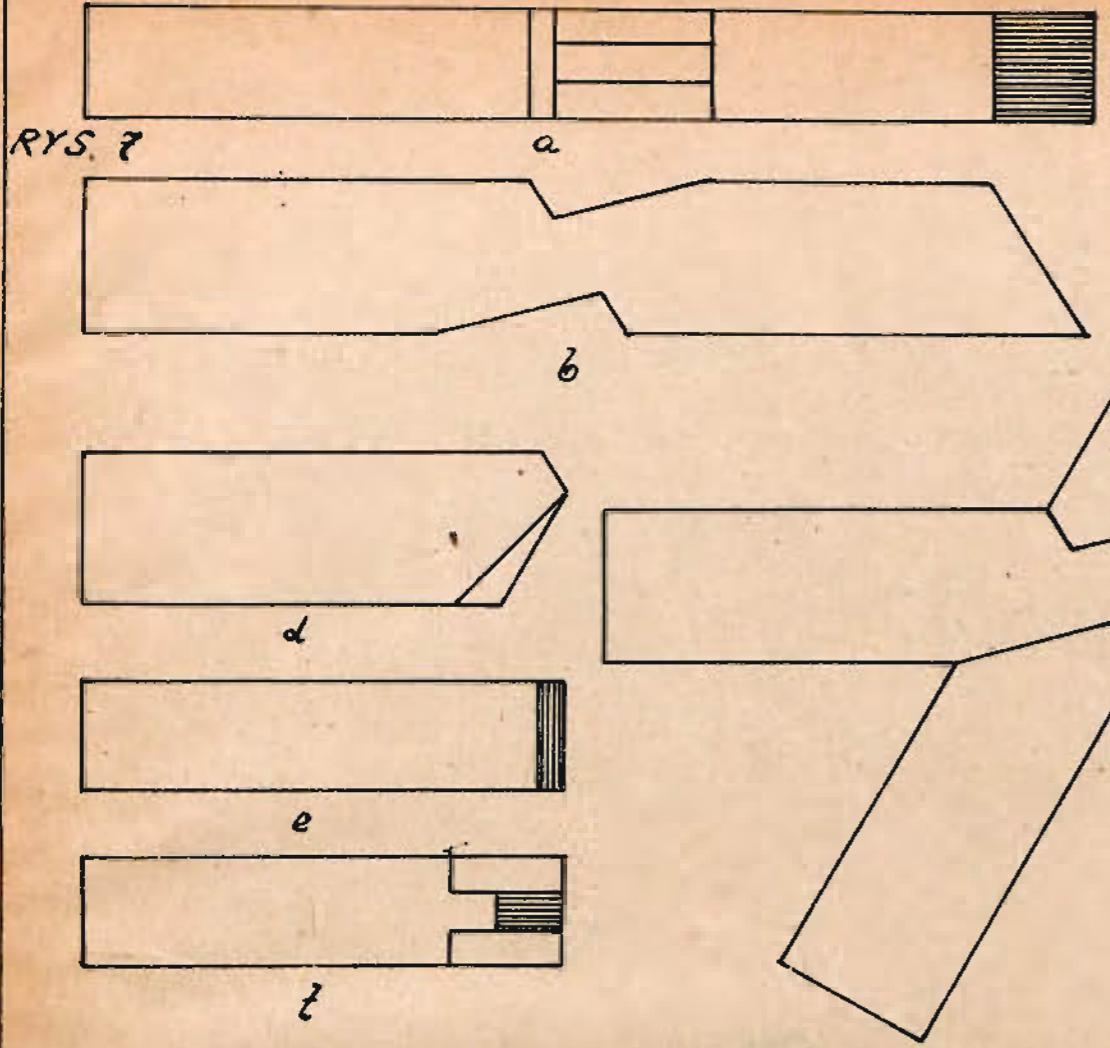

RYS. 9

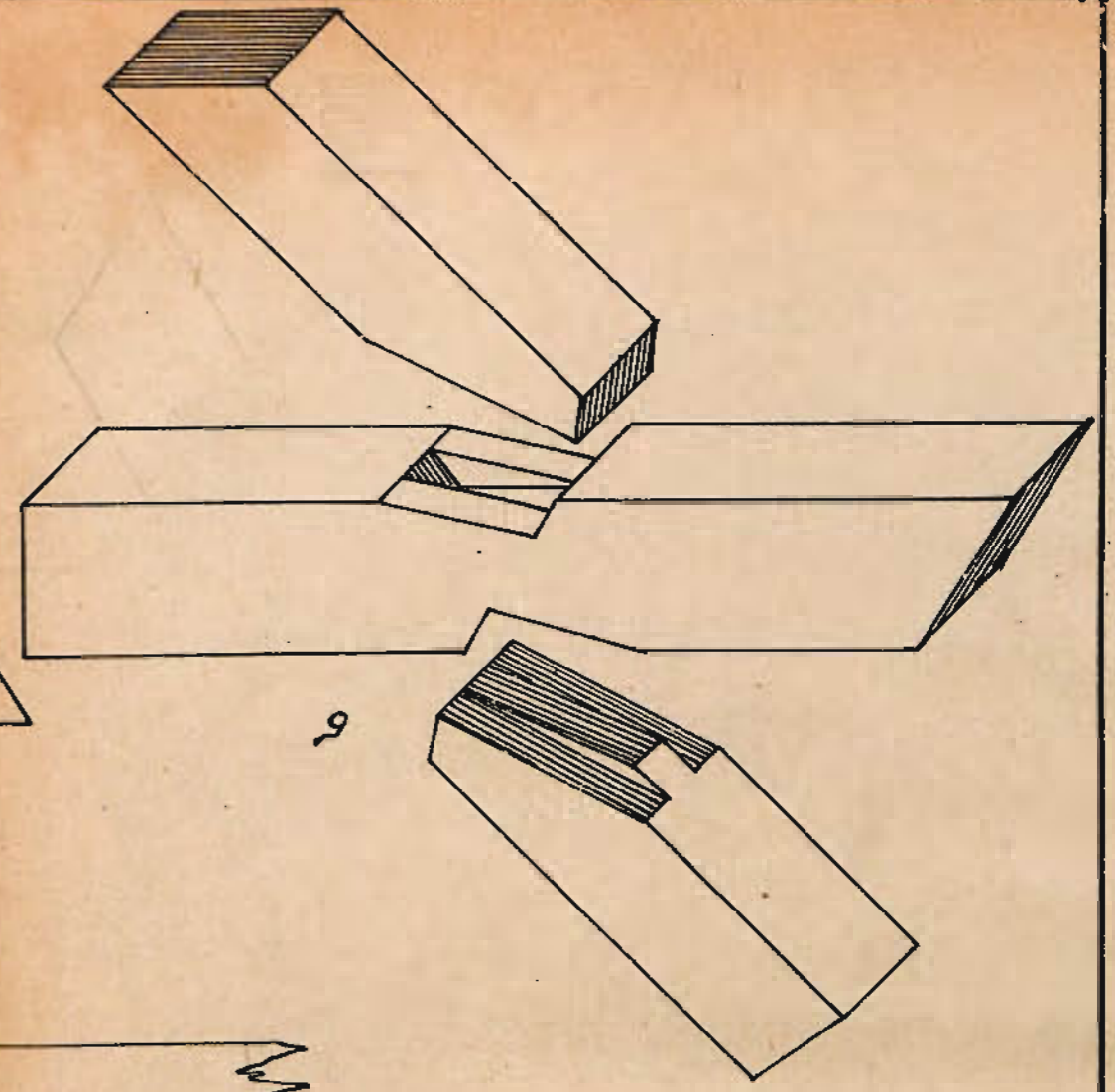
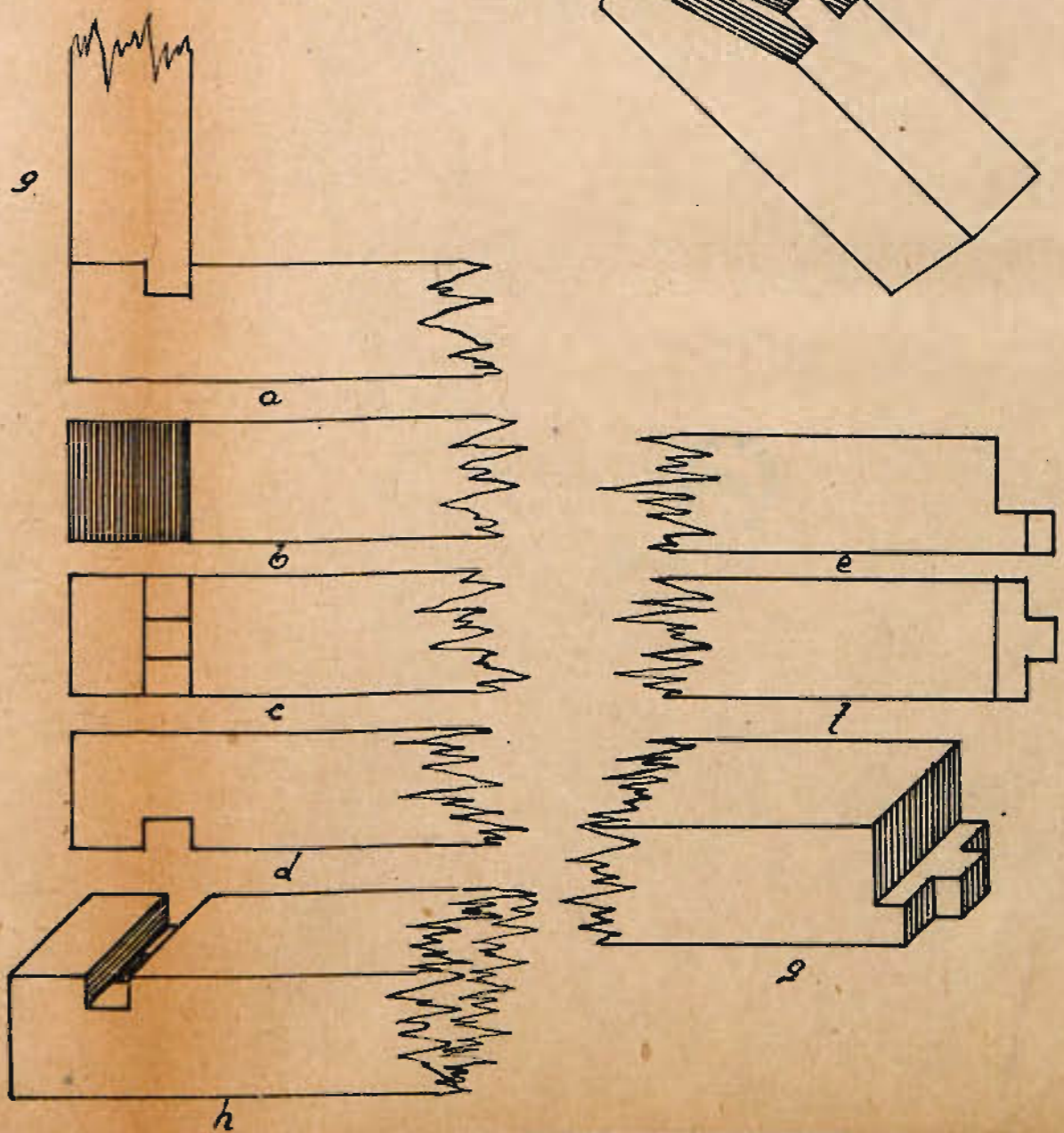

TABL. C

RYS. 10

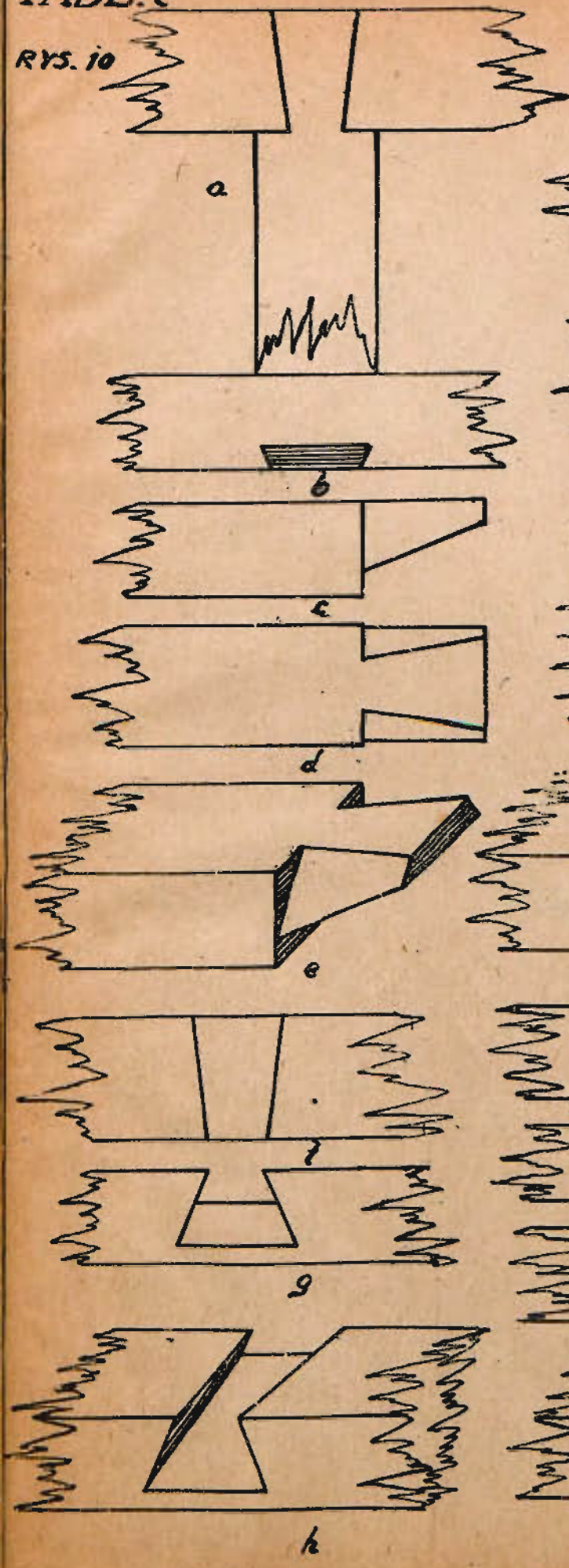

RYS. 11

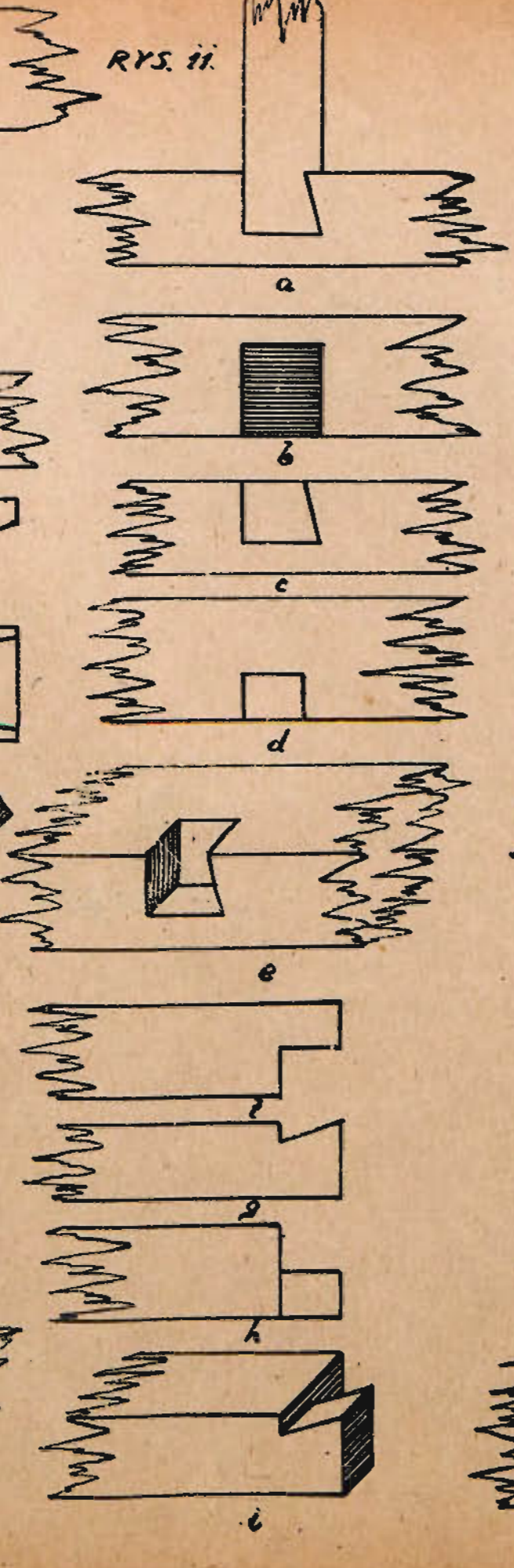

RYS. 12

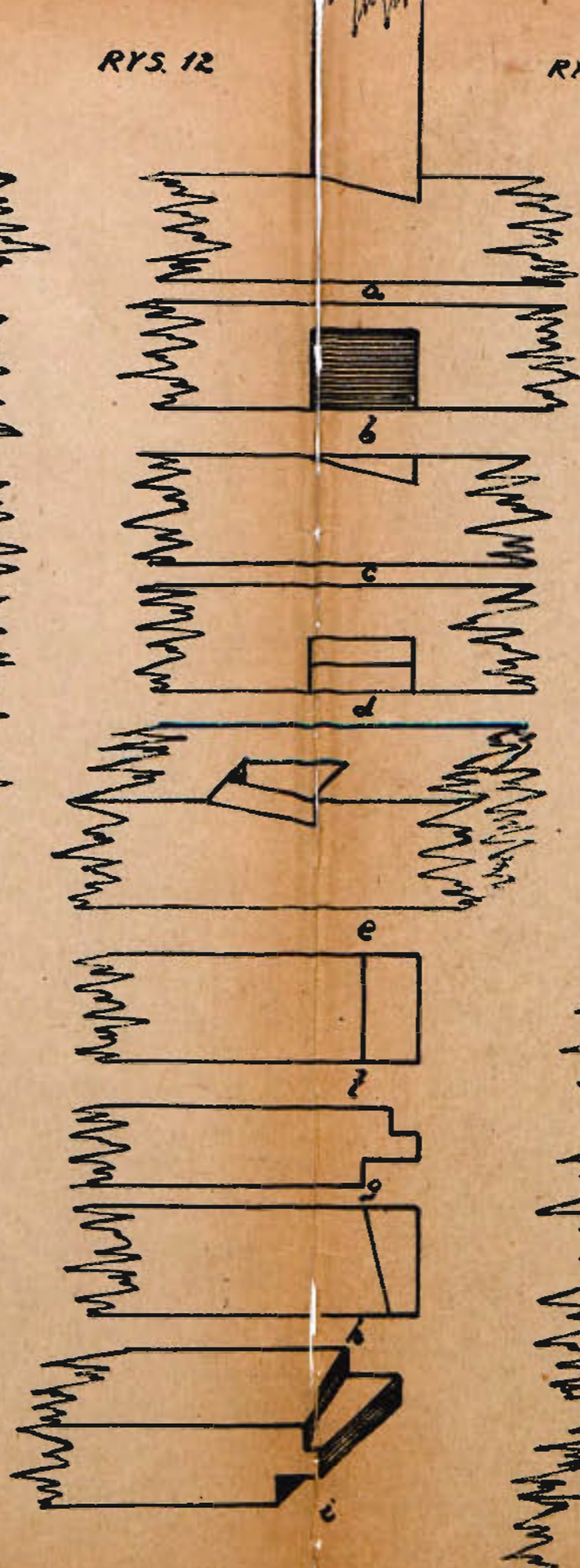

RYS. 13

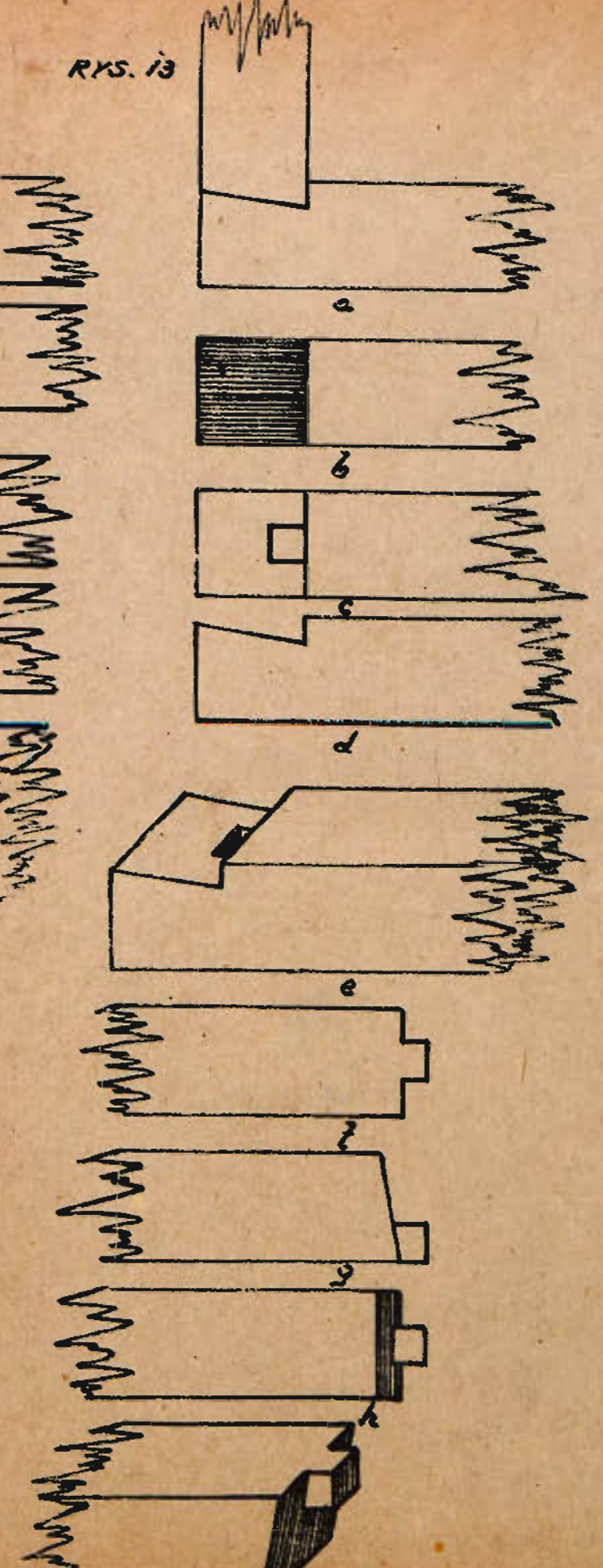

TABL. D.

RYS. 14

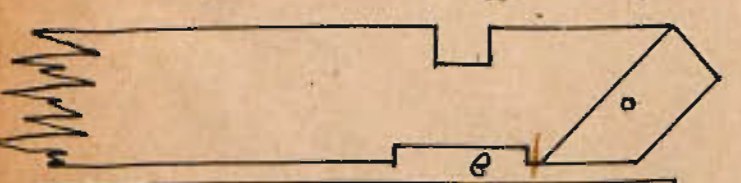
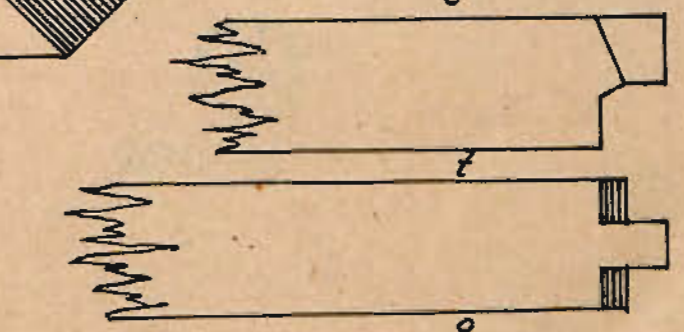
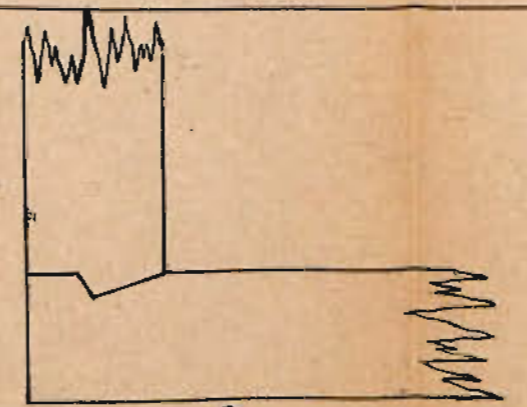
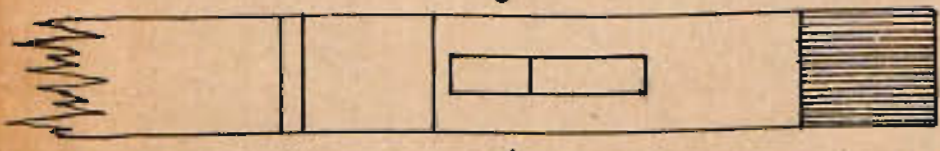
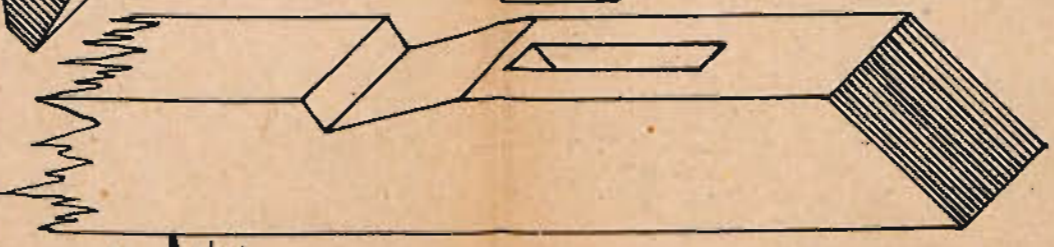
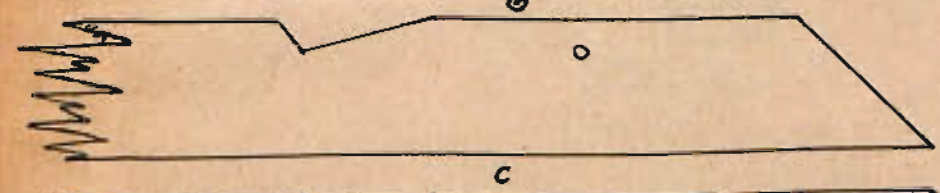
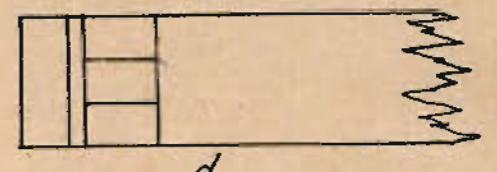
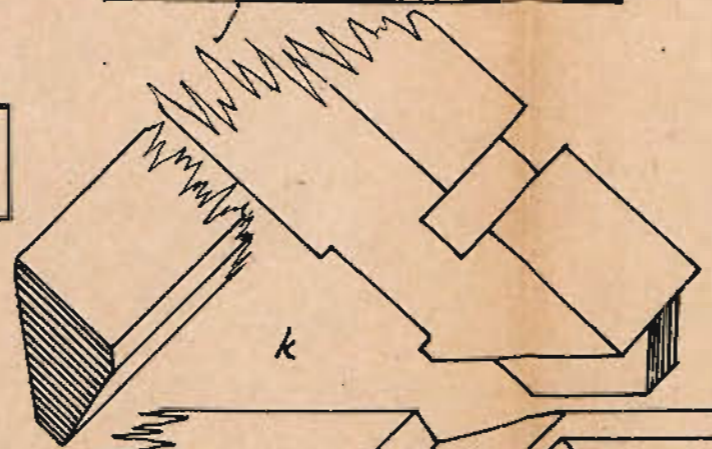
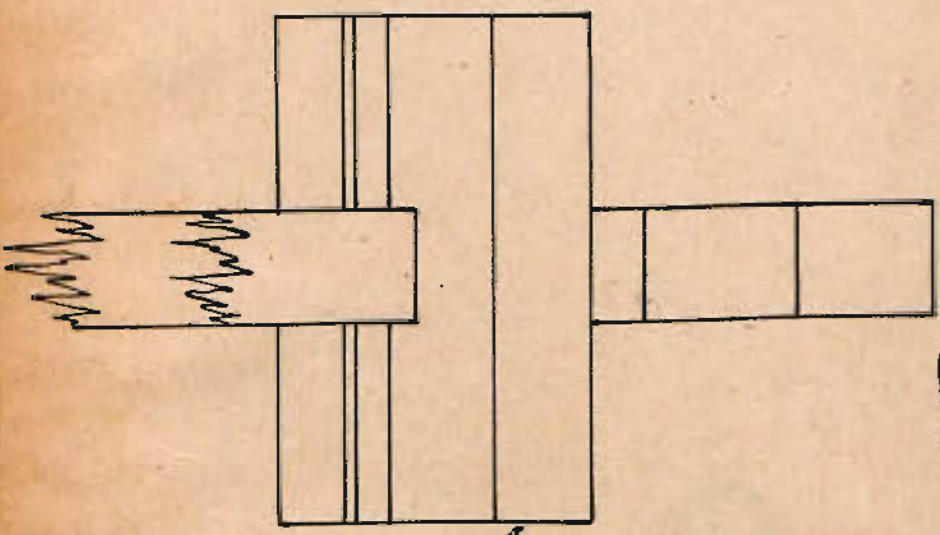
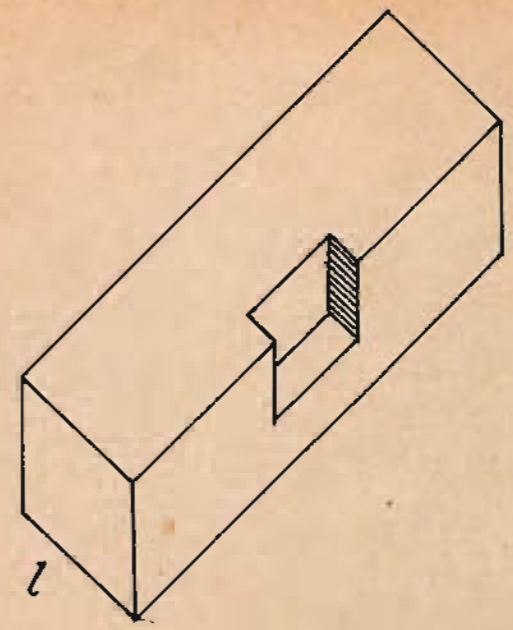
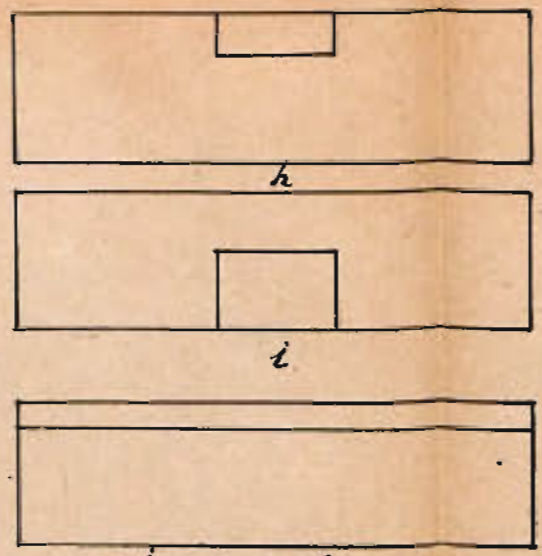
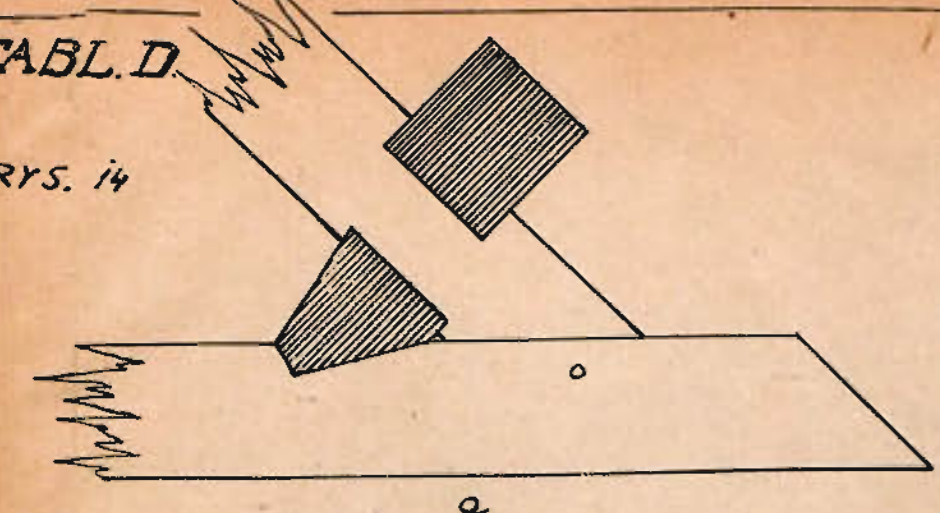

RYS. 15

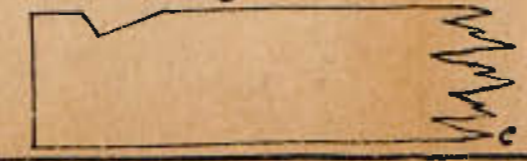
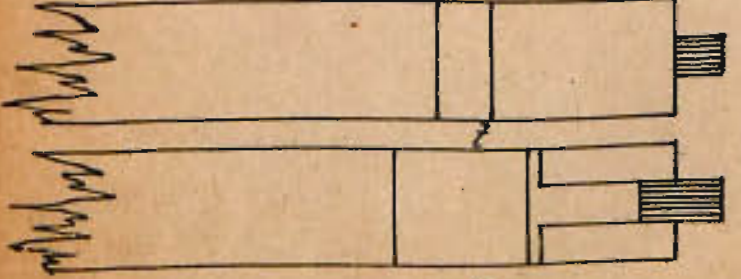
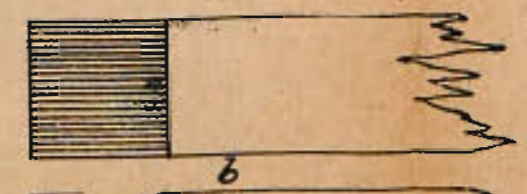

TAB. E.

